

NFPA[®]

14

**Standard for the
Installation of
Standpipe and
Hose Systems**

2019



IMPORTANT NOTICES AND DISCLAIMERS CONCERNING NFPA® STANDARDS

NFPA® codes, standards, recommended practices, and guides (“NFPA Standards”), of which the document contained herein is one, are developed through a consensus standards development process approved by the American National Standards Institute. This process brings together volunteers representing varied viewpoints and interests to achieve consensus on fire and other safety issues. While the NFPA administers the process and establishes rules to promote fairness in the development of consensus, it does not independently test, evaluate, or verify the accuracy of any information or the soundness of any judgments contained in NFPA Standards.

The NFPA disclaims liability for any personal injury, property, or other damages of any nature whatsoever, whether special, indirect, consequential or compensatory, directly or indirectly resulting from the publication, use of, or reliance on NFPA Standards. The NFPA also makes no guaranty or warranty as to the accuracy or completeness of any information published herein.

In issuing and making NFPA Standards available, the NFPA is not undertaking to render professional or other services for or on behalf of any person or entity. Nor is the NFPA undertaking to perform any duty owed by any person or entity to someone else. Anyone using this document should rely on his or her own independent judgment or, as appropriate, seek the advice of a competent professional in determining the exercise of reasonable care in any given circumstances.

The NFPA has no power, nor does it undertake, to police or enforce compliance with the contents of NFPA Standards. Nor does the NFPA list, certify, test, or inspect products, designs, or installations for compliance with this document. Any certification or other statement of compliance with the requirements of this document shall not be attributable to the NFPA and is solely the responsibility of the certifier or maker of the statement.

REVISION SYMBOLS IDENTIFYING CHANGES FROM THE PREVIOUS EDITION

Text revisions are shaded. A **Δ** before a section number indicates that words within that section were deleted and a **Δ** to the left of a table or figure number indicates a revision to an existing table or figure. When a chapter was heavily revised, the entire chapter is marked throughout with the **Δ** symbol. Where one or more sections were deleted, a **•** is placed between the remaining sections. Chapters, annexes, sections, figures, and tables that are new are indicated with an **N**.

Note that these indicators are a guide. Rearrangement of sections may not be captured in the markup, but users can view complete revision details in the First and Second Draft Reports located in the archived revision information section of each code at www.nfpa.org/docinfo. Any subsequent changes from the NFPA Technical Meeting, Tentative Interim Amendments, and Errata are also located there.

REMINDER: UPDATING OF NFPA STANDARDS

Users of NFPA codes, standards, recommended practices, and guides (“NFPA Standards”) should be aware that these documents may be superseded at any time by the issuance of a new edition, may be amended with the issuance of Tentative Interim Amendments (TIAs), or be corrected by Errata. It is intended that through regular revisions and amendments, participants in the NFPA standards development process consider the then-current and available information on incidents, materials, technologies, innovations, and methods as these develop over time and that NFPA Standards reflect this consideration. Therefore, any previous edition of this document no longer represents the current NFPA Standard on the subject matter addressed. NFPA encourages the use of the most current edition of any NFPA Standard [as it may be amended by TIA(s) or Errata] to take advantage of current experience and understanding. An official NFPA Standard at any point in time consists of the current edition of the document, including any issued TIAs and Errata then in effect.

To determine whether an NFPA Standard has been amended through the issuance of TIAs or corrected by Errata, visit the “Codes & Standards” section at www.nfpa.org.

ADDITIONAL IMPORTANT NOTICES AND DISCLAIMERS CONCERNING NFPA® STANDARDS

Updating of NFPA Standards

Users of NFPA codes, standards, recommended practices, and guides ("NFPA Standards") should be aware that these documents may be superseded at any time by the issuance of a new edition, may be amended with the issuance of Tentative Interim Amendments (TIAs), or be corrected by Errata. It is intended that through regular revisions and amendments, participants in the NFPA standards development process consider the then-current and available information on incidents, materials, technologies, innovations, and methods as these develop over time and that NFPA Standards reflect this consideration. Therefore, any previous edition of this document no longer represents the current NFPA Standard on the subject matter addressed. NFPA encourages the use of the most current edition of any NFPA Standard [as it may be amended by TIA(s) or Errata] to take advantage of current experience and understanding. An official NFPA Standard at any point in time consists of the current edition of the document, including any issued TIAs and Errata then in effect.

To determine whether an NFPA Standard has been amended through the issuance of TIAs or corrected by Errata, visit the "Codes & Standards" section at www.nfpa.org.

Interpretations of NFPA Standards

A statement, written or oral, that is not processed in accordance with Section 6 of the Regulations Governing the Development of NFPA Standards shall not be considered the official position of NFPA or any of its Committees and shall not be considered to be, nor be relied upon as, a Formal Interpretation.

Patents

The NFPA does not take any position with respect to the validity of any patent rights referenced in, related to, or asserted in connection with an NFPA Standard. The users of NFPA Standards bear the sole responsibility for determining the validity of any such patent rights, as well as the risk of infringement of such rights, and the NFPA disclaims liability for the infringement of any patent resulting from the use of or reliance on NFPA Standards.

NFPA adheres to the policy of the American National Standards Institute (ANSI) regarding the inclusion of patents in American National Standards ("the ANSI Patent Policy"), and hereby gives the following notice pursuant to that policy:

NOTICE: The user's attention is called to the possibility that compliance with an NFPA Standard may require use of an invention covered by patent rights. NFPA takes no position as to the validity of any such patent rights or as to whether such patent rights constitute or include essential patent claims under the ANSI Patent Policy. If, in connection with the ANSI Patent Policy, a patent holder has filed a statement of willingness to grant licenses under these rights on reasonable and nondiscriminatory terms and conditions to applicants desiring to obtain such a license, copies of such filed statements can be obtained, on request, from NFPA. For further information, contact the NFPA at the address listed below.

Law and Regulations

Users of NFPA Standards should consult applicable federal, state, and local laws and regulations. NFPA does not, by the publication of its codes, standards, recommended practices, and guides, intend to urge action that is not in compliance with applicable laws, and these documents may not be construed as doing so.

Copyrights

NFPA Standards are copyrighted. They are made available for a wide variety of both public and private uses. These include both use, by reference, in laws and regulations, and use in private self-regulation, standardization, and the promotion of safe practices and methods. By making these documents available for use and adoption by public authorities and private users, the NFPA does not waive any rights in copyright to these documents.

Use of NFPA Standards for regulatory purposes should be accomplished through adoption by reference. The term "adoption by reference" means the citing of title, edition, and publishing information only. Any deletions, additions, and changes desired by the adopting authority should be noted separately in the adopting instrument. In order to assist NFPA in following the uses made of its documents, adopting authorities are requested to notify the NFPA (Attention: Secretary, Standards Council) in writing of such use. For technical assistance and questions concerning adoption of NFPA Standards, contact NFPA at the address below.

For Further Information

All questions or other communications relating to NFPA Standards and all requests for information on NFPA procedures governing its codes and standards development process, including information on the procedures for requesting Formal Interpretations, for proposing Tentative Interim Amendments, and for proposing revisions to NFPA standards during regular revision cycles, should be sent to NFPA headquarters, addressed to the attention of the Secretary, Standards Council, NFPA, 1 Batterymarch Park, P.O. Box 9101, Quincy, MA 02269-9101; email: stds_admin@nfpa.org.

For more information about NFPA, visit the NFPA website at www.nfpa.org. All NFPA codes and standards can be viewed at no cost at www.nfpa.org/docinfo.

Copyright © 2018 National Fire Protection Association®. All Rights Reserved.

NFPA® 14

Standard for the

Installation of Standpipe and Hose Systems

2019 Edition

This edition of NFPA 14, *Standard for the Installation of Standpipe and Hose Systems*, was prepared by the Technical Committee on Standpipes. It was issued by the Standards Council on November 5, 2018, with an effective date of November 25, 2018, and supersedes all previous editions.

This edition of NFPA 14 was approved as an American National Standard on November 25, 2018.

Origin and Development of NFPA 14

This standard dates from 1912, when an initial report was made by the Committee on Standpipe and Hose Systems. The report was amended in 1914 and adopted by the Association in 1915. Revisions were adopted in 1917. Additional revisions were submitted by the Committee on Field Practice and adopted in 1926, 1927, 1931, 1938 (included action by the NFPA Board of Directors), 1941, and 1945. The Committee on Standpipes recommended revisions adopted in 1949, 1952, 1963, 1968, 1969, 1970, 1971, 1973, 1974, 1976, 1978, 1980, 1982, 1985, and 1990.

The 1993 edition of NFPA 14 was a complete reorganization of the document. The “user friendliness” of NFPA 14 was evaluated, and numerous changes followed. The standard was arranged to provide for a logical system approach for the design and installation of a standpipe system.

Substantive changes to the 1993 edition were the result of experience with standpipe systems under fire conditions. Flow rates, pressures, and the specific location of the hose connections were studied to determine optimum combinations for each factor.

The 1996 edition of NFPA 14 was a continuation of the changes that had been initiated for the 1993 edition. Some definitions were expanded, and certain requirements for piping materials, pipe support, waterflow alarms, valves, fire department connections, system testing, and water supplies were revised. In addition, a number of editorial changes were made to improve the user friendliness of the document.

The 2000 edition of NFPA 14 incorporated requirements for hydrants, hose houses, and master streams previously contained in NFPA 24, *Standard for the Installation of Private Fire Service Mains and Their Appurtenances*. Also included in this revision were test procedures for fire flow testing and marking of hydrants previously contained in NFPA 291, *Recommended Practice for Fire Flow Testing and Marking of Hydrants*.

The 2003 edition was reformatted to conform to the *Manual of Style for NFPA Technical Committee Documents*, 2000 edition. Hydraulic calculation requirements were rewritten for clarification, and requirements for horizontal standpipes were added. Guidance for hydrants, hose houses, and master streams were deleted as this information was retained by NFPA 13, *Standard for the Installation of Sprinkler Systems*, and NFPA 24, *Standard for the Installation of Private Fire Service Mains and Their Appurtenances*. Similarly, test procedures for fire flow testing and marking of hydrants were returned to NFPA 291, *Recommended Practice for Fire Flow Testing and Marking of Hydrants*; for that reason, “private hydrant” was removed from the title of NFPA 14.

The 2007 edition included guidance on the use of pressure-regulating devices and roof outlets for standpipe systems. Related information was extracted from NFPA 13, *Standard for the Installation of Sprinkler Systems*, to assist the user in applications involving combined sprinkler/standpipe systems.

The 2010 edition permitted express mains supplying higher zone standpipes to be designed with pressures in excess of 350 psi (24 bar). The requirements for standpipe system zones were extensively revised for clarification. The requirements for pipe schedule design were deleted, and all standpipe systems were required to be hydraulically calculated. The requirements to balance hydraulic junction

points were deleted. New requirements were added to address standpipe systems risers that terminate at different floor levels. A new definition for *horizontal standpipe* was added.

The 2013 edition revised clearance requirements around hose valve handles where hose valves are located within cabinets and where adjacent to objects. Travel distance, as it applies to this standard, was defined. The term *horizontal standpipe* was added to the requirement for pipe protection. Heat tracing requirements were clarified, along with added requirements for the pitching of pipe used in a dry system. The valve and drain requirements were extensively revised, providing greater guidance and clarification. New criteria and a new figure regarding horizontal exists also were added.

In the 2016 edition, in Chapter 6, protection of aboveground pipe was revised to clarify the building construction and building types under which standpipe system piping needs to be protected. As a result of that revision, new definitions of construction types were added to Chapter 3. The horizontal exit requirements in Chapter 7 were revised in an effort to align with building code requirements, and new annex figures were added. Subsection 7.3.2 was revised and reorganized in its entirety. Revisions also were made to Section 7.6 clarifying that only partially sprinklered buildings require 6 in. standpipes, while all others, if in a fully sprinklered building, whether combined or not, require only 4 in. standpipes, where supported by hydraulic calculations. The requirement for pressure gauges was revised to no longer require that gauges be listed, only approved.

In the 2019 edition, the terminology has been made consistent throughout the document by changing the terms *outlet(s)* and *hose outlet(s)* to *hose connection(s)*, as this is the more appropriate term. The definitions for the terms *hose connection* and *hose valve* also have been revised to clarify what is meant by each term as used in the document. Definitions and requirements for *distance monitoring* and *automated inspection and testing* have been added because technology now allows for monitoring of certain conditions as well as inspecting and testing standpipe systems from a remote location. A definition for *open parking garage* has been added along with a requirement that permits manual standpipes in open parking garages under a certain height. The signage for pressure requirements is no longer required when the pressure is 150 psi or less, as NFPA 13E requires a standard pressure of 150 psi unless a sign indicates more pressure is required. The maximum pressure permitted at any point in the system has been increased from 350 psi to 400 psi. Subsection 7.8.1 has been revised to clarify that the required pressure is to be calculated at the outlet of the hose valve. The hydraulic calculation procedures have been revised to clarify that additional standpipes should be calculated at the point of connection rather than at the topmost outlet. Subsection 7.11.2 has been revised to delineate between a standpipe system main drain and individual standpipe drains. Revisions have been made to the required number of fire department connections due to the ease with which a single connection can be compromised. A new Chapter 13 on maritime standpipe and hose systems has been added.

Technical Committee on Standpipes

Stephen M. Leyton, *Chair*

Protection Design & Consulting, CA [IM]
Rep. American Fire Sprinkler Association

Cecil Bilbo, Jr., Academy of Fire Sprinkler Technology, Inc., IL [SE]

Chad Binette, Liberty Mutual Insurance, CA [I]

Marinus Both, APi Group Inc., MA [IM]

Don Casey, City Of Mississauga Fire & Emergency Services, Canada [E]

Brian G. Conway, Great Lakes Plumbing & Heating Company, IL [IM]

Rep. Illinois Fire Prevention Association

James Dockrill, J&S Fire Sprinkler Design & Consulting, Canada [IM]

Rep. Canadian Automatic Sprinkler Association

Jeff Hebenstreit, UL LLC, IL [RT]

Andrew M. Henning, CAL FIRE, Office of the State Fire Marshal, CA [E]

Thomas H. Jutras, Engineering Planning & Management, Inc. (EPM), MA [IM]

Rep. New England Association of Fire Protection System Designers

Richard W. Kozel, Livingston Fire Protection, Inc., MD [IM]

Eric Lee, Environmental Systems Design, Inc., IL [SE]

Terence A. Manning, JENSEN HUGHES, AZ [SE]

Scott T. Martorano, The Viking Corporation, MI [M]

Christopher C. Martin, Elkhart Brass Manufacturing Co., Inc., IN [M]

Thomas Meara, FDNY, NY [E]

Rep. Fire Department City of New York

David R. Mettauer, East Texas Fire Protection Ltd., TX [IM]
Rep. National Assoc. of Fire Equipment Distributors

Danny Moran, Fort Lauderdale Fire Department, FL [U]

Bob D. Morgan, Fort Worth Fire Department, TX [E]

Rita L. Neiderheiser, UA Sprinkler Fitters LU 669, CO [L]

Rep. United Assn. of Journeymen & Apprentices of the Plumbing & Pipe Fitting Industry

John W. Norman III, Merrick, NY [SE]

James S. Peterkin, TLC Engineering, PA [SE]

Maurice M. Pilette, Mechanical Designs Ltd., MA [SE]

Edward J. Prendergast, Wolf Technical Services, IL [SE]

Rich Richardson, Seattle Fire Department, WA [E]

Melisa Rodriguez, Leo A Daly, MN [SE]

Daniel Sanchez, City of Los Angeles, CA [E]

Peter T. Schwab, Wayne Automatic Fire Sprinklers, Inc., FL [IM]

Kyle J. Smith, Cobb County Fire & Emergency Services, GA [E]

Mark Summers, Los Alamos National Laboratory, TX [U]

Terry L. Victor, Johnson Controls, MD [M]

Rep. Tyco Fire Protection/JCI

Ronald N. Webb, S.A. Comunale Company, Inc., OH [M]

Rep. National Fire Sprinkler Association

Jim Widmer, Potter Roemer FIRE PRO, AL [M]

Rep. Fire Equipment Manufacturers' Association

Alternates

Donald E. Contois, Robert W. Sullivan, Inc., MA [SE]
(Voting Alternate)

Mark E. Fessenden, Johnson Controls, WI [M]
(Alt. to Terry L. Victor)

Bradley J. Goodrich, CAL FIRE, Office of the State Fire Marshal, CA [E]
(Alt. to Andrew M. Henning)

Jerry Graupman, Great Lakes Plumbing & Heating Company, IL [IM]
(Alt. to Brian G. Conway)

Louis Guerrazzi, National Fire Sprinkler Association, MD [M]
(Alt. to Ronald N. Webb)

Bryan P. Horn, Western States Fire Protection, CO [IM]
(Alt. to Marinus Both)

Charles W. Ketner, National Automatic Sprinkler Fitters LU 669, MD [L]
(Alt. to Rita L. Neiderheiser)

Michael Wade McDaniel, F Tech, Mexico [SE]
(Alt. to Cecil Bilbo, Jr.)

Ronald B. Melucci, Engineering Planning & Management, Inc., MA [IM]

(Alt. to Thomas H. Jutras)

Ryan Peterson, Wayne Auto Fire Sprinklers, FL [IM]
(Alt. to Peter T. Schwab)

Jason W. Ryckman, Canadian Automatic Sprinkler Association, Canada [IM]
(Alt. to James Dockrill)

Jeff Saunders, Wilson & Cousins Interior Fire Protection, Canada [M]
(Alt. to Jim Widmer)

Christopher Sobieski, Cobb County Fire & Emergency Services, GA [E]
(Alt. to Kyle J. Smith)

Daniel R. Weaver, UL LLC, IL [RT]
(Alt. to Jeff Hebenstreit)

Janna E. Shapiro, NFPA Staff Liaison

This list represents the membership at the time the Committee was balloted on the final text of this edition. Since that time, changes in the membership may have occurred. A key to classifications is found at the back of the document.

NOTE: Membership on a committee shall not in and of itself constitute an endorsement of the Association or any document developed by the committee on which the member serves.

Committee Scope: This Committee shall have primary responsibility for documents on the installation of standpipes and hose systems in buildings and structures.

Contents

Chapter 1 Administration	14-6	7.10 Flow Rates.	14-22
1.1 Scope.	14-6	7.11 Drains and Test Riser.	14-23
1.2 Purpose.	14-6	7.12 Fire Department Connections.	14-24
1.3 Retroactivity.	14-6	Chapter 8 Plans and Calculations	14-24
1.4 Equivalency.	14-6	8.1 Plans and Specifications.	14-24
1.5 Units.	14-6	8.2 Hydraulic Calculations.	14-25
Chapter 2 Referenced Publications	14-7	8.3 Hydraulic Calculation Procedures.	14-25
2.1 General.	14-7	Chapter 9 Water Supply	14-27
2.2 NFPA Publications.	14-7	9.1 Required Water Supply.	14-27
2.3 Other Publications.	14-7	9.2 Minimum Supply for Class I, Class II, and Class III Systems.	14-27
2.4 References for Extracts in Mandatory Sections.	14-8	Chapter 10 Water Supply Testing	14-27
Chapter 3 Definitions	14-8	10.1 Water Supply Evaluation.	14-27
3.1 General.	14-8	10.2 Procedure.	14-27
3.2 NFPA Official Definitions.	14-8	Chapter 11 System Acceptance	14-27
3.3 General Definitions.	14-8	11.1 General.	14-27
Chapter 4 System Components and Hardware	14-10	11.2 Flushing of Piping.	14-27
4.1 General.	14-10	11.3 Hose Threads.	14-27
4.2 Pipe and Tube.	14-10	11.4 Hydrostatic Tests.	14-27
4.3 Fittings.	14-11	11.5 Flow Tests.	14-33
4.4 Joining of Pipe and Fittings.	14-12	11.6 Manual Valve Test.	14-34
4.5 Valves.	14-13	11.7 Automated Inspection and Testing Devices and Equipment.	14-34
4.6 Hose Stations.	14-13	11.8 Alarm and Supervision Tests.	14-34
4.7 Hose Connections.	14-14	11.9 Record Drawings, Test Reports, and Manuals.	14-34
4.8 Fire Department Connections.	14-14	11.10 Signs.	14-34
4.9 Pressure-Regulating Devices.	14-14	Chapter 12 Buildings Under Construction	14-34
4.10 Signs.	14-14	12.1 General.	14-34
Chapter 5 System Requirements	14-14	12.2 Fire Department Connections.	14-34
5.1 General.	14-14	12.3 Other System Features.	14-34
5.2 Automatic and Semiautomatic Dry Systems.	14-14	12.4 Support of Piping.	14-34
5.3 Classes of Standpipe Systems.	14-16	12.5 Hose Connections.	14-34
5.4 Required Type of System.	14-16	12.6 Extension of System Piping.	14-34
5.5 Gauges.	14-16	12.7 Temporary Installations.	14-34
5.6 Waterflow and Supervisory Alarms.	14-17	12.8 Timing of Water Supply Installation.	14-34
Chapter 6 Installation Requirements	14-17	12.9 Protection of Hose Connections and Fire Department Connections.	14-34
6.1 Location and Protection of Piping.	14-17	Chapter 13 Maritime Standpipes and Hose Systems	14-35
6.2 Underground Piping.	14-18	13.1 Application.	14-35
6.3 Gate Valves and Check Valves.	14-18	13.2 Components and Hardware.	14-35
6.4 Fire Department Connections.	14-19	13.3 System Requirements.	14-36
6.5 Support of Piping.	14-19	13.4 Installation.	14-36
6.6 Installation of Signs.	14-19	13.5 Design.	14-37
6.7 Signs for Water Supply Pumps.	14-19	13.6 Plans and Calculations.	14-38
6.8 Hydraulic Design Information Sign.	14-19	13.7 Water Supply.	14-38
Chapter 7 Design	14-20	13.8 Water Supply Testing.	14-38
7.1 General.	14-20	13.9 System Acceptance.	14-38
7.2 Pressure Limitation.	14-20	13.10 System Inspection, Testing, and Maintenance.	14-38
7.3 Locations of Hose Connections.	14-20	Annex A Explanatory Material	14-38
7.4 Number of Standpipes.	14-21	Annex B Informational References	14-56
7.5 Interconnection of Standpipes.	14-21	Index	14-57
7.6 Minimum Sizes for Standpipes and Branch Lines, Class I and Class III Standpipes.	14-21		
7.7 System Design and Sizing of Pipe for Delivery of System Demand.	14-22		
7.8 Minimum and Maximum Pressure Limits.	14-22		
7.9 Standpipe System Zones.	14-22		

NFPA 14

Standard for the

Installation of Standpipe and Hose Systems

2019 Edition

IMPORTANT NOTE: This NFPA document is made available for use subject to important notices and legal disclaimers. These notices and disclaimers appear in all publications containing this document and may be found under the heading "Important Notices and Disclaimers Concerning NFPA Standards." They can also be viewed at www.nfpa.org/disclaimers or obtained on request from NFPA.

UPDATES, ALERTS, AND FUTURE EDITIONS: New editions of NFPA codes, standards, recommended practices, and guides (i.e., NFPA Standards) are released on scheduled revision cycles. This edition may be superseded by a later one, or it may be amended outside of its scheduled revision cycle through the issuance of Tentative Interim Amendments (TIAs). An official NFPA Standard at any point in time consists of the current edition of the document, together with all TIAs and Errata in effect. To verify that this document is the current edition or to determine if it has been amended by TIAs or Errata, please consult the National Fire Codes® Subscription Service or the "List of NFPA Codes & Standards" at www.nfpa.org/docinfo. In addition to TIAs and Errata, the document information pages also include the option to sign up for alerts for individual documents and to be involved in the development of the next edition.

NOTICE: An asterisk (*) following the number or letter designating a paragraph indicates that explanatory material on the paragraph can be found in Annex A.

A reference in brackets [] following a section or paragraph indicates material that has been extracted from another NFPA document. As an aid to the user, the complete title and edition of the source documents for extracts in mandatory sections of the document are given in Chapter 2 and those for extracts in informational sections are given in Annex B. Extracted text may be edited for consistency and style and may include the revision of internal paragraph references and other references as appropriate. Requests for interpretations or revisions of extracted text shall be sent to the technical committee responsible for the source document.

Information on referenced publications can be found in Chapter 2 and Annex B.

Chapter 1 Administration

1.1 Scope.

1.1.1 This standard covers the minimum requirements for the installation of standpipes and hose systems.

1.1.2* This standard does not cover requirements for periodic inspection, testing, and maintenance of these systems.

1.2 Purpose.

1.2.1 The purpose of this standard is to provide a reasonable degree of protection for life and property from fire through installation requirements for standpipes and hose systems based on sound engineering principles, test data, and field experience.

1.2.2 Nothing in this standard is intended to restrict new technologies or alternate arrangements, provided that the level of safety prescribed by the standard is not lowered.

1.3 **Retroactivity.** The provisions of this standard reflect a consensus of what is necessary to provide an acceptable degree of protection from the hazards addressed in this standard at the time the standard was issued.

1.3.1 Unless otherwise specified, the provisions of this standard shall not apply to facilities, equipment, structures, or installations that existed or were approved for construction or installation prior to the effective date of the standard. Where specified, the provisions of this standard shall be retroactive.

1.3.2 In those cases where the authority having jurisdiction (AHJ) determines that the existing situation presents an unacceptable degree of risk, the AHJ shall be permitted to apply retroactively any portions of this standard deemed appropriate.

1.3.3 The retroactive requirements of this standard shall be permitted to be modified if their application clearly would be impractical in the judgment of the AHJ, and only where it is clearly evident that a reasonable degree of safety is provided.

1.4* **Equivalency.** Nothing in this standard is intended to prevent the use of systems, methods, or devices of equivalent or superior quality, strength, fire resistance, effectiveness, durability, and safety over those prescribed by this standard.

1.4.1 Technical documentation shall be submitted to the AHJ to demonstrate equivalency.

1.4.2 The system, method, or device shall be approved for the intended purpose by the AHJ.

1.5 Units.

Δ 1.5.1 Metric units of measurement in this standard are in accordance with the modernized metric system known as the International System of Units (SI). Liter and bar units, which are outside of but recognized by SI, are commonly used in international fire protection. These units and their conversion factors are provided in Table 1.5.1.

1.5.2 If a value for measurement provided in this standard is followed by an equivalent value in other units, the first value stated shall be regarded as the requirement. An equivalent value could be approximate.

1.5.3 Where sizes for pipe, sheet and plate steel, and wire gauges are indicated, they are noted in trade sizes and not by hard conversions.

Table 1.5.1 Metric Units of Measure

Name of Unit	Unit Symbol	Conversion Factor
meter	m	1 ft = 0.3048 m
millimeter	mm	1 in. = 25.4 mm
liter	L	1 gal = 3.785 L
cubic decimeter	dm ³	1 gal = 3.785 dm ³
Pascal	Pa	1 psi = 6894.757 Pa
bar	bar	1 psi = 0.0689 bar
bar	bar	1 bar = 10 ⁵ Pa

Note: For additional conversion and information, see IEEE/ASTM SI 10, *American National Standard for Metric Practice*.

Chapter 2 Referenced Publications

2.1 General. The documents or portions thereof listed in this chapter are referenced within this standard and shall be considered part of the requirements of this document.

2.2 NFPA Publications. National Fire Protection Association, 1 Batterymarch Park, Quincy, MA 02169-7471.

NFPA 13, *Standard for the Installation of Sprinkler Systems*, 2019 edition.

NFPA 13R, *Standard for the Installation of Sprinkler Systems in Low-Rise Residential Occupancies*, 2019 edition.

NFPA 20, *Standard for the Installation of Stationary Pumps for Fire Protection*, 2019 edition.

NFPA 22, *Standard for Water Tanks for Private Fire Protection*, 2018 edition.

NFPA 24, *Standard for the Installation of Private Fire Service Mains and Their Appurtenances*, 2019 edition.

NFPA 25, *Standard for the Inspection, Testing, and Maintenance of Water-Based Fire Protection Systems*, 2017 edition.

NFPA 51B, *Standard for Fire Prevention During Welding, Cutting, and Other Hot Work*, 2019 edition.

NFPA 72[®], *National Fire Alarm and Signaling Code[®]*, 2019 edition.

NFPA 101[®], *Life Safety Code[®]*, 2018 edition.

NFPA 170, *Standard for Fire Safety and Emergency Symbols*, 2018 edition.

NFPA 1963, *Standard for Fire Hose Connections*, 2019 edition.

2.3 Other Publications.

2.3.1 ANSI Publications. American National Standards Institute, Inc., 25 West 43rd Street, 4th Floor, New York, NY 10036.

ANSI Z97.1, *Safety Glazing Materials Used in Buildings — Safety Performance Specifications and Methods of Test*, 2015.

Δ 2.3.2 ASME Publications. American Society of Mechanical Engineers, Two Park Avenue, New York, NY 10016-5990.

ASME B1.20.1, *Pipe Threads, General Purpose (Inch)*, 2013.

ASME B16.1, *Gray Iron Pipe Flanges and Flanged Fittings: Classes 25, 125, and 250*, 2015.

ASME B16.3, *Malleable Iron Threaded Fittings: Classes 150 and 300*, 2016.

ANSI/ASME B16.4, *Gray Iron Threaded Fittings: Classes 125 and 250*, 2016.

ASME B16.5, *Pipe Flanges and Flanged Fittings, NPS 1/2 Through NPS 24 Metric/Inch Standard*, 2013.

ANSI/ASME B16.9, *Factory-Made Wrought Butt Welding Fittings*, 2012.

ASME B16.11, *Forged Fittings, Socket-Welding and Threaded*, 2016.

ASME B16.15, *Cast Copper Alloy Threaded Fittings: Classes 125 and 250*, 2013.

ASME B16.18, *Cast Copper Alloy Solder Joint Pressure Fittings*, 2012.

ASME B16.22, *Wrought Copper and Copper Alloy Solder-Joint Pressure Fittings*, 2013.

ASME B16.25, *Butt Welding Ends*, 2012.

ANSI/ASME B36.10M, *Welded and Seamless Wrought Steel Pipe*, 2015.

Boiler and Pressure Vessel Code, 2017.

2.3.3 ASTM Publications. ASTM International, 100 Barr Harbor Drive, P.O. Box C700, West Conshohocken, PA 19428-2959.

ASTM A53/A53M, *Standard Specification for Pipe, Steel, Black and Hot-Dipped, Zinc-Coated, Welded and Seamless*, 2012.

ASTM A135/A135M, *Standard Specification for Electric-Resistance-Welded Steel Pipe*, 2009, reapproved 2014.

ASTM A234/A234M, *Standard Specification for Piping Fittings of Wrought Carbon Steel and Alloy Steel for Moderate and High Temperature Service*, 2016.

ASTM A795/A795M, *Standard Specification for Black and Hot-Dipped Zinc-Coated (Galvanized) Welded and Seamless Steel Pipe for Fire Protection Use*, 2013.

ASTM B32, *Standard Specifications for Solder Metal*, 2008 (2014).

ASTM B43, *Standard Specification for Seamless Red Brass Pipe, Standard Sizes*, 2015.

ASTM B75/B75M, *Standard Specification for Seamless Copper Tube*, 2011.

ASTM B88, *Standard Specification for Seamless Copper Water Tube*, 2016.

ASTM B251, *Standard Specification for General Requirements for Wrought Seamless Copper and Copper-Alloy Tube*, 2010.

ASTM B446, *Standard Specification for Nickel-Chromium-Molybdenum-Columbium Alloy (UNS N06625), Nickel-Chromium-Molybdenum-Silicon Alloy (UNS N06219), and Nickel-Chromium-Molybdenum-Tungsten Alloy (UNS N06650) Rod and Bar*, 2003 (2014).

ASTM F437, *Standard Specification for Threaded Chlorinated Poly(Vinyl Chloride) (CPVC) Plastic Pipe Fittings, Schedule 80*, 2015.

ASTM F438, *Standard Specification for Socket-Type Chlorinated Poly(Vinyl Chloride) (CPVC) Plastic Pipe Fittings, Schedule 40*, 2015.

ASTM F439, *Standard Specification for Chlorinated Poly(Vinyl Chloride) (CPVC) Plastic Pipe Fittings, Schedule 80*, 2013.

ASTM F442/F442M, *Standard Specification for Chlorinated Poly(Vinyl Chloride) (CPVC) Plastic Pipe (SDR-PR)*, 2013e1.

ASTM F2164, *Standard Practice for Field Leak Testing of Polyethylene (PE) and Crosslinked Polyethylene (PEX) Pressure Piping Systems Using Hydrostatic Pressure*, 2013.

ASTM F2620, *Standard Practice for Heat Fusion Joining of Polyethylene Pipe and Fittings*, 2013.

2.3.4 AWS Publications. American Welding Society, 8669 NW 36 Street, #130, Miami, FL 33166-6672.

AWS A5.8M/A5.8, *Specification for Filler Metals for Brazing and Braze Welding*, 2011, Amendment 1, 2012.

AWS B2.1/B2.1M, *Specification for Welding Procedure and Performance Qualification*, 2014, Amendment 1, 2015.

AWS D10.9, *Specification for Qualification of Welding Procedures and Welders for Piping and Tubing*, 1980.

Δ 2.3.5 **AWWA Publications.** American Water Works Association, 6666 West Quincy Avenue, Denver, CO 80235.

AWWA C104/A21.4, *Cement-Mortar Lining for Ductile-Iron Pipe and Fittings*, 2016.

AWWA C105/A21.5, *Polyethylene Encasement for Ductile-Iron Pipe Systems*, 2010.

AWWA C110, *Ductile-Iron and Gray-Iron Fittings*, 2012.

AWWA C111/A21.11, *Rubber-Gasket Joints for Ductile-Iron Pressure Pipe and Fittings*, 2017.

AWWA C115, *Flanged Ductile-Iron Pipe with Ductile-Iron or Gray-Iron Threaded Flanges*, 2011.

AWWA C116, *Protective Fusion-Bonded Coatings for the Interior and Exterior Surfaces of Ductile-Iron and Gray-Iron Fittings*, 2015.

AWWA C150, *Thickness Design of Ductile-Iron Pipe*, 2014.

AWWA C151/A21.51, *Ductile-Iron Pipe, Centrifugally Cast, for Water*, 2017.

AWWA C153, *Ductile-Iron Compact Fittings*, 2011.

AWWA C600, *Installation of Ductile-Iron Water Mains and Their Appurtenances*, 2010.

AWWA C900, *Polyvinyl Chloride (PVC) Pressure Pipe and Fabricated Fittings, 4 in. Through 60 in. (100 mm Through 1,500 mm)*, 2016.

AWWA C905, *Polyvinyl Chloride (PVC) Pressure Pipe and Fabricated Fittings, 14 in. Through 48 in. (350 mm Through 1,200 mm), for Water Transmission and Distribution*, 2010.

AWWA C906, *Polyethylene (PE) Pressure Pipe and Fittings, 4 in. Through 65 in. (100 mm Through 1,650 mm), for Waterworks*, 2015.

Δ 2.3.6 **IEEE Publications.** IEEE, Three Park Avenue, 17th Floor, New York, NY, 10016-5997.

IEEE/ASTM SI 10, *American National Standard for Metric Practice*, 2016.

2.3.7 Other Publications.

Merriam-Webster's Collegiate Dictionary, 11th edition, Merriam-Webster, Inc., Springfield, MA, 2003.

2.4 References for Extracts in Mandatory Sections.

NFPA 13, *Standard for the Installation of Sprinkler Systems*, 2019 edition.

NFPA 24, *Standard for the Installation of Private Fire Service Mains and Their Appurtenances*, 2019 edition.

NFPA 101®, *Life Safety Code®*, 2018 edition.

NFPA 241, *Standard for Safeguarding Construction, Alteration, and Demolition Operations*, 2018 edition.

NFPA 1002, *Standard for Fire Apparatus Driver/Operator Professional Qualifications*, 2017 edition.

NFPA 5000®, *Building Construction and Safety Code®*, 2018 edition.

Chapter 3 Definitions

3.1 General. The definitions contained in this chapter shall apply to the terms used in this standard. Where terms are not defined in this chapter or within another chapter, they shall be defined using their ordinarily accepted meanings within the context in which they are used. *Merriam-Webster's Collegiate Dictionary*, 11th edition, shall be the source for the ordinarily accepted meaning.

3.2 NFPA Official Definitions.

3.2.1* Approved. Acceptable to the authority having jurisdiction.

3.2.2* Authority Having Jurisdiction (AHJ). An organization, office, or individual responsible for enforcing the requirements of a code or standard, or for approving equipment, materials, an installation, or a procedure.

3.2.3* Listed. Equipment, materials, or services included in a list published by an organization that is acceptable to the authority having jurisdiction and concerned with evaluation of products or services, that maintains periodic inspection of production of listed equipment or materials or periodic evaluation of services, and whose listing states that either the equipment, material, or service meets appropriate designated standards or has been tested and found suitable for a specified purpose.

3.2.4 Shall. Indicates a mandatory requirement.

3.2.5 Should. Indicates a recommendation or that which is advised but not required.

3.2.6 Standard. An NFPA Standard, the main text of which contains only mandatory provisions using the word "shall" to indicate requirements and that is in a form generally suitable for mandatory reference by another standard or code or for adoption into law. Nonmandatory provisions are not to be considered a part of the requirements of a standard and shall be located in an appendix, annex, footnote, informational note, or other means as permitted in the NFPA Manuals of Style. When used in a generic sense, such as in the phrase "standards development process" or "standards development activities," the term "standards" includes all NFPA Standards, including Codes, Standards, Recommended Practices, and Guides.

3.3 General Definitions.

ℵ 3.3.1 **Automated Inspection and Testing.** The performance of inspections and tests at a distant location from the system or component being inspected or tested through the use of electronic devices or equipment installed for that purpose.

3.3.2* Auxiliary Drain Connection. A drain connection installed to permit draining water from a trapped section of pipe.

3.3.3 Branch Line. A piping system, generally in a horizontal plane, connecting not more than one hose connection with a standpipe.

3.3.4 Connection.

3.3.4.1 Fire Department Connection.

3.3.4.1.1 Fire Department Connection for Automatic Standpipe Systems. A connection through which the fire department can pump the secondary water supply to an automatic stand-

pipe system at the required system demand. Supplemental water can also be provided into the sprinkler system or other system furnishing water for fire extinguishment to supplement existing water supplies.

3.3.4.1.2 Fire Department Connection for Manual Standpipe Systems. A connection through which the fire department can pump the primary water supply to a manual standpipe system at the required system demand.

3.3.4.2 Hose Connection. The outlet of a hose valve installed on a standpipe system for the connection of fire hose.

3.3.5* Construction Types.

3.3.5.1 Type I and Type II Construction. Those types in which the fire walls, structural elements, walls, arches, floors, and roofs are of approved noncombustible or limited-combustible materials.

3.3.5.2 Type III Construction. That type in which exterior walls and structural elements that are portions of exterior walls are of approved noncombustible or limited-combustible materials and in which fire walls, interior structural elements, walls, arches, floors, and roofs are entirely or partially of wood of smaller dimensions than required for Type IV construction or are of approved noncombustible, limited-combustible, or other approved combustible materials.

3.3.5.3 Type IV Construction. That type in which fire walls, exterior walls, and interior bearing walls and structural elements that are portions of such walls are of approved noncombustible or limited-combustible materials. Other interior structural elements, arches, floors, and roofs are constructed of solid or laminated wood or cross-laminated timber without concealed spaces within allowable dimensions of the building code.

3.3.5.4 Type V Construction. That type in which structural elements walls, arches, floors, and roofs are entirely or partially of wood or other approved material.

N 3.3.6 Distance Monitoring. The monitoring of various conditions of a system or component from a location distant from the system or component through the use of electronic devices, meters, or equipment installed for that purpose.

3.3.7 Exit.

3.3.7.1 Exit Passageway. Hallways, corridors, passages, or tunnels used as exit components and separated from other parts of the building in accordance with NFPA 101.

3.3.7.2* Horizontal Exit. A way of passage from one building to an area of refuge in another building on approximately the same level, or a way of passage through or around a fire barrier to an area of refuge on approximately the same level in the same building that affords safety from fire and smoke originating from the area of incidence and areas communicating therewith. [101, 2018]

3.3.8 Fire Department. An organization providing rescue, fire suppression, and related activities, including any public, governmental, private, industrial, or military organization engaging in this type of activity. [1002, 2017]

3.3.9 High-Rise Building. A building where the floor of an occupiable story is greater than 75 ft (23 m) above the lowest level of fire department vehicle access. [5000, 2018]

3.3.10 Hose Station. A combination of a hose rack or reel, hose nozzle, hose, and hose connection.

3.3.11 Main.

3.3.11.1 Feed Main. The portion of a standpipe system that supplies water to one or more standpipes.

3.3.11.1.1 Express Main. A type of feed main supplying only the upper zone(s) of a standpipe system.

3.3.12 Main Drain. The primary drain connection located on the system riser and also utilized as a test connection.

N 3.3.13 Open Parking Garage. A structure or portion of a structure with openings as prescribed by the adopted building code that is used for the parking or storage of private motor vehicles.

3.3.14 Pressure.

3.3.14.1 Nozzle Pressure. Pressure required at the inlet of a nozzle to produce the desired water discharge characteristics.

3.3.14.2 Residual Pressure. For standpipe systems, pressure acting on a point in the system with a flow being delivered.

3.3.14.3 Static Pressure. For standpipe systems, pressure acting on a point in the system with no flow from the system.

3.3.15 Pressure Control Valve. A pilot-operated pressure-reducing valve designed for the purpose of reducing the downstream water pressure to a specific value under both flowing (residual) and nonflowing (static) conditions.

3.3.16* Pressure-Regulating Device. A device designed for the purpose of reducing, regulating, controlling, or restricting water pressure.

3.3.16.1* Pressure-Reducing Valve. A valve designed for the purpose of reducing the downstream water pressure under both flowing (residual) and nonflowing (static) conditions.

3.3.16.2 Pressure-Restricting Device. A valve or device designed for the purpose of reducing the downstream water pressure under flowing (residual) conditions only.

3.3.17 Rated Capacity. The flow available from a device, at the designated residual pressure either measured or calculated.

3.3.18 Record Drawing. A design, working drawing, or as-built drawing that is submitted as the final record of documentation for the project.

3.3.19 Standpipe. The system piping that delivers the water supply for hose connections, and for sprinklers on combined systems, vertically from floor to floor.

Δ 3.3.19.1 Horizontal Standpipe. The system piping that delivers the water supply for two or more hose connections, and for sprinklers on combined systems, on a single level.

3.3.20* Standpipe System. An arrangement of piping, valves, hose connections, and associated equipment installed in a building or structure, with the hose connections located in such a manner that water can be discharged in streams or spray patterns through attached hose and nozzles, for the purpose of extinguishing a fire, thereby protecting a building or structure and its contents in addition to protecting the occupants.

3.3.20.1 Automatic Dry Standpipe System. A standpipe system permanently attached to a water supply capable of supplying the system demand at all times, containing air or nitrogen under pressure, the release of which (as from opening a hose valve) opens a dry pipe valve to allow water to flow into the piping system and out of the opened hose valve.

3.3.20.2 Automatic Wet Standpipe System. A standpipe system containing water at all times that is attached to a water supply capable of supplying the system demand at all times and that requires no action other than opening a hose valve to provide water at hose connections.

3.3.20.3 Combined System. A standpipe system that supplies both hose connections and automatic sprinklers.

3.3.20.4 Manual Dry Standpipe System. A standpipe system with no permanently attached water supply that relies exclusively on the fire department connection to supply the system demand.

3.3.20.5 Manual Wet Standpipe System. A standpipe system containing water at all times that relies exclusively on the fire department connection to supply the system demand.

3.3.20.6 Semiautomatic Dry Standpipe System. A standpipe system permanently attached to a water supply that is capable of supplying the system demand at all times arranged through the use of a device such as a deluge valve and that requires activation of a remote control device to provide water at hose connections.

3.3.20.7 Wet Standpipe System. A standpipe system having piping containing water at all times.

3.3.21 Standpipe System Zone. A vertical subdivision of a standpipe system limited or determined by the pressure limitations of the system components.

3.3.22* System Classes.

3.3.22.1 Class I System. A system that provides 2½ in. (65 mm) hose connections to supply water for use by fire departments.

3.3.22.2 Class II System. A system that provides 1½ in. (40 mm) hose stations to supply water for use primarily by trained personnel or by the fire department during initial response.

3.3.22.3 Class III System. A system that provides 1½ in. (40 mm) hose stations to supply water for use by trained personnel and 2½ in. (65 mm) hose connections to supply a larger volume of water for use by fire departments.

3.3.23 System Demand. The flow rate and residual pressure required from a water supply, measured at the point of connection of a water supply to a standpipe system, to deliver the total waterflow rate and the minimum residual pressures required for a standpipe system at the hydraulically most remote hose connection, and the minimum waterflow rate and residual pressure for sprinkler connections on combined systems.

Δ 3.3.24 System Working Pressure. The maximum anticipated static (nonflowing) or flowing pressure applied to standpipe system components exclusive of surge pressures.

3.3.25 Travel Distance. The length measured on the floor or other walking surface along the centerline of the natural path

of travel, starting from the hose connection, curving around any corners or obstructions with a 12 in. (300 mm) clearance.

3.3.26 Valve.

Δ 3.3.26.1* Control Valve. A valve controlling flow to water-based fire protection systems.

3.3.26.2 Hose Valve. The valve to an individual hose connection with an outlet for attaching a fire hose.

Chapter 4 System Components and Hardware

4.1* General.

4.1.1 Standpipe system components and hardware shall be in accordance with this chapter.

4.1.2 All devices and materials used in standpipe systems shall be listed, except as permitted in 4.1.3, 4.1.4, 4.2.1, and 4.3.1.

4.1.3* Components that do not affect system performance shall not be required to be listed.

N 4.1.4 Automated Inspection, Testing, and Distance Monitoring Devices, Meters, and Equipment.

N 4.1.4.1* Where provided, devices, meters, and equipment utilized to perform automated inspection and testing procedures that are not subjected to system pressure shall not be required to be listed.

N 4.1.4.2* Where provided, devices, meters, and equipment utilized to perform distance monitoring of system or component status that are not subjected to system pressure shall not be required to be listed.

4.2 Pipe and Tube.

Δ 4.2.1 Pipe or tube used in standpipe systems shall meet or exceed one of the standards in Table 4.2.1 or shall be in accordance with 4.2.2 through 4.2.6.

4.2.2 Where ductile-iron pipe is installed in accordance with Table 4.2.1, it shall be lined in accordance with AWWA C104/A21.4, *Cement-Mortar Lining for Ductile-Iron Pipe and Fittings*.

4.2.3 Where steel pipe specified in Table 4.2.1 is used and joined by welding as specified in Section 4.4 or by roll-grooved pipe and fittings as specified in Section 4.4, the minimum nominal wall thickness for pressures up to 300 psi (20.7 bar) shall be in accordance with Schedule 10 for pipe sizes up to 5 in. (127 mm), 0.134 in. (3.40 mm) for 6 in. (150 mm) pipe, and 0.188 in. (4.78 mm) for 8 in. and 10 in. (203 mm and 254 mm) pipe.

4.2.3.1 Pressure limitations and wall thickness for steel pipe listed in accordance with 4.2.6 shall be in accordance with the listing requirements.

4.2.4 Where steel pipe specified in Table 4.2.1 is joined by threaded fittings as specified in Section 4.4 or by fittings used with pipe having cut grooves, the minimum wall thickness shall be in accordance with Schedule 30 [sizes 8 in. (203 mm) and larger] or Schedule 40 [sizes less than 8 in. (203 mm)] pipe for pressures up to 300 psi (20.7 bar).

4.2.4.1 Pressure limitations and wall thicknesses for steel pipe specially listed in accordance with 4.2.6 shall be in accordance with the listing requirements.

Table 4.2.1 Pipe or Tube Materials and Dimensions

Materials and Dimensions (Specifications)	Standard
Ferrous piping	
<i>Ductile-Iron Pipe, Centrifugally Cast, for Water</i>	AWWA C151/A21.51
<i>Flanged Ductile-Iron Pipe with Ductile-Iron or Gray-Iron Threaded Flanges</i>	AWWA C115
Electric-resistance-welded steel pipe	
<i>Standard Specification for Electric-Resistance-Welded Steel Pipe</i>	ASTM A135/A135M
Welded and seamless steel	
<i>Standard Specification for Black and Hot-Dipped Zinc-Coated (Galvanized) Welded and Seamless Steel Pipe for Fire Protection Use</i>	ASTM A795/A795M
Welded and seamless steel pipe	
<i>Standard Specification for Pipe, Steel, Black and Hot-Dipped, Zinc-Coated, Welded and Seamless Welded and Seamless Wrought Steel Pipe</i>	ASTM A53/A53M ANSI/ASME B36.10M
Copper tube (drawn, seamless)	
<i>Standard Specification for Seamless Copper Tube</i>	ASTM B75/B75M
<i>Standard Specification for Seamless Copper Water Tube</i>	ASTM B88
<i>Standard Specification for General Requirements for Wrought Seamless Copper and Copper-Alloy Tube</i>	ASTM B251
Brazing filler metal	
<i>Specification for Filler Metals for Brazing and Braze Welding (classifications BCuP-3 or BCuP-4)</i>	AWS A5.8M/A5.8
<i>Standard Specification for Solder Metal</i>	ASTM B32
<i>Standard Specification for Nickel-Chromium-Molybdenum-Columbium Alloy (UNS N06625), Nickel-Chromium-Molybdenum-Silicon Alloy (UNS N06219), and Nickel-Chromium-Molybdenum-Tungsten Alloy (UNS N06650) Rod and Bar</i>	ASTM B446
Brass Pipe	
<i>Standard Specification for Seamless Red Brass Pipe, Standard Sizes</i>	ASTM B43

4.2.5 Copper tube as specified in the standards referenced in Table 4.2.1 shall have a wall thickness of Type K, L, or M where used in standpipe systems.

4.2.6 Other types of pipe or tube investigated for use in standpipe installations and listed for this service, including, but not limited to, steel differing from that provided in Table 4.2.1, shall be permitted where installed in accordance with their listing limitations, including installation instructions.

4.2.6.1 Pipe or tube shall not be listed for portions of an occupancy classification.

4.2.7 Bending of Pipe and Tube.

4.2.7.1 Bending of Schedule 40 steel pipe and Types K and L copper tube shall be permitted where bends are made with no kinks, ripples, distortions, reductions in diameter, or any noticeable deviations from a round shape.

4.2.7.2 The minimum radius of a bend shall be six pipe diameters for pipe sizes 2 in. (50 mm) and smaller, and five pipe diameters for pipe sizes 2½ in. (65 mm) and larger.

4.3 Fittings.

4.3.1 Fittings used in standpipe systems shall meet or exceed the standards in Table 4.3.1 or shall be in accordance with 4.3.2.

4.3.2 Other types of fittings investigated for suitability in standpipe installations and listed for this service, including, but not limited to, steel differing from that provided in Table 4.3.1, shall be permitted where installed in accordance with their listing limitations, including installation instructions.

4.3.3 Fittings shall be extra-heavy pattern where pressures exceed 175 psi (12.1 bar).

4.3.3.1 Standard weight pattern cast-iron fittings 2 in. (50 mm) in size and smaller shall be permitted where pressures do not exceed 300 psi (20.7 bar).

4.3.3.2 Standard weight pattern malleable-iron fittings 6 in. (150 mm) in size and smaller shall be permitted where pressures do not exceed 300 psi (20.7 bar).

4.3.3.3 Fittings shall be permitted for system pressures up to the limits specified in their listings.

Table 4.3.1 Fittings Materials and Dimensions

Materials and Dimensions	Standard
Cast Iron	
<i>Gray Iron Threaded Fittings: Classes 125 and 250</i>	ANSI/ASME B16.4
<i>Gray Iron Pipe Flanges and Flanged Fittings: Classes 25, 125, and 250</i>	ASME B16.1
Malleable Iron	
<i>Malleable Iron Threaded Fittings: Classes 150 and 300</i>	ASME B16.3
Ductile Iron	
<i>Ductile-Iron and Gray-Iron Fittings</i>	AWWA C110
<i>Ductile-Iron Compact Fittings</i>	AWWA C153
Steel	
<i>Factory-Made Wrought Butt Welding Fittings</i>	ANSI/ASME B16.9
<i>Butt Welding Ends</i>	ASME B16.25
<i>Standard Specification for Piping Fittings of Wrought Carbon Steel and Alloy Steel for Moderate and High Temperature Service</i>	ASTM A234/A234M
<i>Pipe Flanges and Flanged Fittings, NPS ½ through NPS 24 Metric/Inch Standard Forged Fittings, Socket-Welding and Threaded</i>	ASME B16.5
	ASME B16.11
Copper	
<i>Wrought Copper and Copper Alloy Solder-Joint Pressure Fittings</i>	ASME B16.22
<i>Cast Copper Alloy Solder Joint Pressure Fittings</i>	ASME B16.18
Bronze	
<i>Cast Copper Alloy Threaded Fittings: Classes 125 and 250</i>	ASME B16.15

Shaded text = Revisions. Δ = Text deletions and figure/table revisions. • = Section deletions. N = New material.

4.3.4 Screwed unions shall not be used on pipe larger than 2 in. (50 mm).

4.3.4.1 Couplings and unions of other than the screwed type shall be of the types listed specifically for use in standpipe systems.

4.3.5 A one-piece reducing fitting or coupling shall be used wherever a change is made in the size of the pipe.

4.3.5.1* Hexagonal or face bushings shall be permitted for reducing the size of openings of fittings where standard fittings of the required size are not available.

4.4 Joining of Pipe and Fittings.

4.4.1 Threaded Pipe and Fittings.

4.4.1.1 All threaded pipe and fittings shall have threads cut to ASME B1.20.1, *Pipe Threads, General Purpose (Inch)*. [13:7.5.1.1]

4.4.1.2* Steel pipe with wall thicknesses less than Schedule 30 [in sizes 8 in. (200 mm) and larger] or Schedule 40 [in sizes less than 8 in. (200 mm)] shall only be permitted to be joined by threaded fittings where the threaded assembly is investigated for suitability in automatic sprinkler installations and listed for this service. [13:7.5.1.2]

Δ 4.4.1.3 Joint compound or tape shall be applied only to male threads.

4.4.2 Welded Pipe and Fittings.

4.4.2.1 General.

4.4.2.1.1 Welding shall be permitted as a means of joining standpipe piping in accordance with 4.4.2.2 through 4.4.2.6.

4.4.2.2* Fabrication.

4.4.2.2.1 When standpipe piping is welded, the pipe shall be shop-welded unless the requirements of 4.4.2.2 are met.

4.4.2.2.2 Where the design specifications require any part of the piping system to be welded in place, welding of standpipe piping shall be permitted where the welding process is performed in accordance with NFPA 51B.

4.4.2.2.3 Tabs for longitudinal earthquake bracing shall be permitted to be welded to in-place piping where the welding process is performed in accordance with NFPA 51B. [13:7.5.2.2.3]

4.4.2.2.4 Welding shall not be performed where there is impingement of rain, snow, sleet, or high wind on the weld area of the pipe product. [13:7.5.2.2.4]

4.4.2.2.5 Torch cutting and welding shall not be permitted as a means of modifying or repairing standpipe systems.

4.4.2.3 Fittings.

4.4.2.3.1* Welded fittings used to join pipe shall be listed fabricated fittings or manufactured in accordance with Table 4.3.1. [13:7.5.2.3.1]

4.4.2.3.2 Fittings referenced in 4.4.2.3.1 shall be joined in conformance with a qualified welding procedure as set forth in this section and shall be an acceptable product under this standard, provided that materials and wall thickness are compatible with other sections of this standard. [13:7.5.2.3.2]

4.4.2.3.3 Fittings shall not be required where pipe ends are butt-welded in accordance with the requirements of 4.4.2.4.3. [13:7.5.2.3.3]

4.4.2.3.4 When the pipe size in a run of piping is reduced, a reducing fitting designed for that purpose shall be used in accordance with the requirements of 4.4.2.3.1. [13:7.5.2.3.4]

4.4.2.4 Welding Requirements.

4.4.2.4.1* Welds between pipe and welding outlet fittings shall be permitted to be attached by full penetration welds, partial penetration groove welds, or fillet welds. [13:7.5.2.4.1]

4.4.2.4.2 The minimum throat thickness shall be not less than the thickness of the pipe, the thickness of the welding fitting, or $\frac{3}{16}$ in. (4.5 mm), whichever is least. [13:7.5.2.4.2]

4.4.2.4.3* Circumferential butt joints shall be cut, beveled, and fit so that full penetration is achievable. [13:7.5.2.4.3]

4.4.2.4.4 Full penetration welding shall not be required. [13:7.5.2.4.4]

4.4.2.4.5 Where slip-on flanges are welded to pipe with a single fillet weld, the weld shall be on the hub side of the flange and the minimum throat weld thickness shall not be less than 1.25 times the pipe wall thickness or the hub thickness, whichever is less. [13:7.5.2.4.5]

4.4.2.4.6 Face welds on the internal face of the flange shall be permitted as a water seal in addition to the hub weld required in 4.4.2.4.5. [13:7.5.2.4.6]

4.4.2.4.7 Tabs for longitudinal earthquake bracing shall have minimum throat weld thickness not less than 1.25 times the pipe wall thickness and welded on both sides of the longest dimension. [13:7.5.2.4.7]

4.4.2.4.8 When welding is performed, the following shall apply:

- (1) Holes in piping for outlets shall be cut to the full inside diameter of fittings prior to welding in place of the fittings.
- (2) Discs shall be retrieved.
- (3) Openings cut into piping shall be smooth bore, and all internal slag and welding residue shall be removed.
- (4) Fittings shall not penetrate the internal diameter of the piping.
- (5) Steel plates shall not be welded to the ends of piping or fittings.
- (6) Fittings shall not be modified.
- (7) Nuts, clips, eye rods, angle brackets, or other fasteners shall not be welded to pipe or fittings, except as permitted in 4.4.2.2.3 and 4.4.2.4.7.
- (8) Completed welds shall be free from cracks, incomplete fusion, surface porosity greater than $\frac{1}{16}$ in. (1.6 mm) diameter, and undercut deeper than 25 percent of the wall thickness or $\frac{1}{32}$ in. (0.8 mm), whichever is less.
- (9) Completed circumferential butt weld reinforcement shall not exceed $\frac{3}{32}$ in. (2 mm).

[13:7.5.2.4.8]

4.4.2.5 Qualifications.

4.4.2.5.1 A welding procedure shall be prepared and qualified by the contractor or fabricator before any welding is done. [13:7.5.2.5.1]

4.4.2.5.2 Qualification of the welding procedure to be used and the performance of all welders and welding operators shall be required and shall meet or exceed the requirements of AWS B2.1/B2.1M, *Specification for Welding Procedure and Performance Qualification*; ASME Boiler and Pressure Vessel Code, Section IX, "Welding, Brazing, and Fusing Qualifications"; or other applicable qualification standard as required by the AHJ, except as permitted by 4.4.2.5.3. [13:7.5.2.5.2]

4.4.2.5.3 Successful procedure qualification of complete joint penetration groove welds shall qualify partial joint penetration (groove/fillet) welds and fillet welds in accordance with the provisions of this standard. [13:7.5.2.5.3]

4.4.2.5.4 Welding procedures qualified under standards recognized by previous editions of this standard shall be permitted to be continued in use. [13:7.5.2.5.4]

4.4.2.5.5 Contractors or fabricators shall be responsible for all welding they produce. [13:7.5.2.5.5]

4.4.2.5.6 Each contractor or fabricator shall have available to the AHJ an established written quality assurance procedure ensuring compliance with the requirements of 4.4.2.4. [13:7.5.2.5.6]

4.4.2.6 Records.

4.4.2.6.1 Welders or welding machine operators shall, upon completion of each welded pipe, place their identifiable mark or label onto each piece adjacent to a weld. [13:7.5.2.6.1]

4.4.2.6.2 Contractors or fabricators shall maintain certified records, which shall be available to the AHJ, of the procedures used and the welders or welding machine operators employed by them, along with their welding identification. [13:7.5.2.6.2]

4.4.2.6.3 Records shall show the date and the results of procedure and performance qualifications. [13:7.5.2.6.3]

4.4.3 Groove Joining Methods.

4.4.3.1 Pipe, fittings, valves, and devices to be joined with grooved couplings shall contain cut, rolled, or cast grooves that are dimensionally compatible with the couplings. [13:7.5.3.1]

4.4.3.1.1 Pipe, fittings, valves, devices, and couplings that conform with or are listed in compliance with standardized groove specifications shall be considered compatible. [13:7.5.3.1.1]

4.4.3.1.2 Other groove dimensions and grooving methods shall be acceptable in accordance with 4.4.5.1. [13:7.5.3.1.2]

4.4.3.2 Grooved couplings, including gaskets used on dry pipe, preaction, and deluge systems, shall be listed for dry service. [13:7.5.3.2]

4.4.4* Brazed Joints.

4.4.4.1 Joints for the connection of copper tube shall be brazed.

4.4.4.2 Brazing fluxes, if used, shall not be of a highly corrosive type. [13:7.5.4.6]

4.4.5 Other Joining Methods.

Δ 4.4.5.1 Other joining methods investigated for suitability in sprinkler installations and listed for this service shall be permitted where installed in accordance with their listing limitations, including installation instructions. [13:7.5.5.1]

4.4.5.2 Outlet Fittings. Rubber-gasketed outlet fittings that are used on standpipe systems shall meet the following requirements:

- (1) Be installed in accordance with the listing and manufacturer's installation instructions
 - (2) Have all disks retrieved
 - (3) Have smooth bores cut into the pipe, with all cutting residue removed
 - (4) Not be modified
- [13:7.5.5.2]

4.4.6 End Treatment.

4.4.6.1 After cutting, pipe ends shall have burrs and fins removed. [13:7.5.6.1]

4.4.6.2 Pipe used with listed fittings and its end treatment shall be in accordance with the fitting manufacturer's installation instructions and the fitting's listing. [13:7.5.6.2]

4.5 Valves.

4.5.1 All valves controlling connections to water supplies and standpipes shall be listed indicating valves.

4.5.1.1 A listed underground gate valve equipped with a listed indicator post shall be permitted.

4.5.1.2 A listed water control valve assembly with a position indicator connected to a remote supervisory station shall be permitted.

4.5.1.3 A nonindicating valve, such as an underground gate valve with approved roadway box complete with T-wrench, acceptable to AHJ, shall be permitted.

4.5.2 All valves controlling connection to water supplies and standpipes shall not close in less than 5 seconds when operated at maximum possible speed from the fully open position.

N 4.5.3 Automated Valves. A listed indicating valve with an automatic means to operate the valve shall be permitted.

N 4.5.3.1 A listed water control valve assembly with an automatic means to operate the valve shall be connected to a remote supervisory station.

N 4.5.3.2 A listed water control valve assembly with an automatic means to operate the valve shall include a visual position indicator.

N 4.5.3.3 A listed water control valve assembly with an automatic means to operate the valve shall be able to be operated manually as well as automatically.

4.6 Hose Stations.

4.6.1 Closets and Cabinets.

4.6.1.1 Closets and cabinets used to contain fire hose shall be of a size to allow the installation of the necessary equipment at hose stations and designed so they do not interfere with the prompt use of the hose connection, the hose, and other equipment at the time of fire.

4.6.1.1.1 Within the cabinet, the hose connections shall be located so that there are at least 2 in. (50 mm) between any part of the cabinet, other than the door and the handle of the valve when the valve is in any position ranging from fully open to fully closed.

4.6.1.1.2 The cabinet shall be used for fire equipment only, and each cabinet shall be conspicuously identified.

4.6.1.2 Where a “break glass”-type protective cover for a latching device is provided, the device provided to break the glass panel shall be attached in the immediate area of the break glass panel and shall be arranged so that the device cannot be used to break other glass panels in the cabinet door.

4.6.1.2.1 All glazing shall be either tempered safety glass or plastic glazing in accordance with ANSI Z97.1, *Safety Glazing Materials Used in Buildings — Safety Performance Specifications and Methods of Test*.

4.6.1.3 Where a fire-resistive assembly is penetrated by a cabinet, the fire resistance of the assembly shall be maintained as required by the local building code.

4.6.1.4 Hose cabinets shall be marked to indicate the contents.

4.6.2 Hose.

4.6.2.1* Each hose connection provided for use by trained personnel (Class II and Class III systems) shall be equipped with not more than 100 ft (30.5 m) of listed, 1½ in. (40 mm), lined, collapsible or noncollapsible fire hose attached and ready for use.

4.6.2.2 Where hose less than 1½ in. (40 mm) is used for 1½ in. (40 mm) hose stations in accordance with 5.3.2 and 5.3.3, listed noncollapsible hose shall be used.

4.6.3 Hose Racks.

4.6.3.1 Each 1½ in. (40 mm) hose station provided with 1½ in. (40 mm) hose shall be equipped with a listed rack or approved storage method.

4.6.3.2 Each 1½ in. (40 mm) hose station provided with hose less than 1½ in. (40 mm) in accordance with 5.3.2 and 5.3.3 shall be equipped with a listed continuous flow reel.

4.6.4 Nozzles. Nozzles provided for Class II service shall be listed.

4.6.5* Label. Each rack or storage facility for 1½ in. (40 mm) or smaller hose shall be provided with a label that includes the wording “FIRE HOSE FOR USE BY TRAINED PERSONNEL” and operating instructions.

4.7 Hose Connections.

4.7.1 Hose valves shall be listed.

4.7.2 Hose connections shall have external National Hose Standard (NHS) threads, for the valve size specified, in accordance with NFPA 1963.

4.7.3 Hose connections shall be equipped with threaded caps to protect the hose threads.

4.7.4 Where local fire department hose threads do not conform to NFPA 1963, the AHJ shall designate the hose threads that shall be used.

4.7.5* Hose connections shall be located so that there is at least 3 in. (76.2 mm) clearance between any adjacent object and the handle of the valve when the valve is in any position ranging from fully open to fully closed.

4.8 Fire Department Connections. (See Figure A.6.4.)

4.8.1 Fire department connections shall be listed for a working pressure equal to or greater than the pressure requirement of the system demand.

4.8.2 Unless the requirements of 4.8.2.1 or 4.8.2.2 are met, the fire department connection(s) shall have at least two 2½ in. (65 mm) connections using NH internal threaded swivel fitting(s) with 2.5–7.5 NH standard thread, as specified in NFPA 1963. (See Sections 7.7 and 7.12 for design requirements.)

4.8.2.1 Where local fire department connections do not conform to NFPA 1963, the AHJ shall be permitted to designate the connection to be used.

4.8.2.2 The use of threadless couplings shall be permitted where required by the AHJ and where listed for such use.

4.8.3 Fire department connections shall be equipped with approved plugs or caps, properly secured, and arranged for easy removal by fire departments.

4.8.4 Fire department connections shall be of an approved type.

4.9 Pressure-Regulating Devices. Pressure-regulating devices shall be listed.

4.10 Signs. Signs shall be permanently marked and shall be constructed of weather-resistant metal or rigid plastic materials.

Chapter 5 System Requirements

5.1 General.

5.1.1 The number and arrangement of standpipe equipment necessary for protection shall be governed by local conditions such as the occupancy, character, and construction of the building and its accessibility.

5.1.2* The AHJ shall be consulted regarding the required type of system, class of system, and special requirements.

5.1.3 The spacing and location of standpipes and hose connections shall be in accordance with Chapter 7.

5.2 Automatic and Semiautomatic Dry Systems.

5.2.1* Automatic Dry.

5.2.1.1 Pressure Gauges. Approved pressure gauges in accordance with Section 5.5 shall be connected as follows:

- (1) On the water side and air side of the dry pipe valve
- (2) At the air pump supplying the air receiver where one is provided
- (3) At the air receiver where one is provided
- (4) In each independent pipe from air supply to dry pipe system
- (5) At quick-opening devices

[13:8.2.1]

5.2.1.2 Size of Systems Volume Limitations.

5.2.1.2.1* Not more than 750 gal (2839 L) system capacity shall be controlled by one dry pipe valve.

5.2.1.2.2 Piping volume shall be permitted to exceed the requirements of 5.2.1.2.1 where the system design is such that water is delivered to the system at the most remote hose connection in not more than 3 minutes, starting at the normal air pressure on the system and at the time of fully opened hose connection.

5.2.1.2.3 The use of a listed quick opening device shall be permitted in order to meet the requirements of 5.2.1.2.2.

5.2.1.3* Location and Protection of Dry Pipe Valve. [13:8.2.5]

5.2.1.3.1* General. The dry pipe valve and supply pipe shall be protected against freezing and mechanical injury. [13:8.2.5.1]

5.2.1.3.2 Valve Rooms. [13:8.2.5.2]

5.2.1.3.2.1 Valve rooms shall be lighted and heated. [13:8.2.5.2.1]

5.2.1.3.2.2 The source of heat shall be of a permanently installed type. [13:8.2.5.2.2]

5.2.1.3.2.3 Heat tape shall not be used in lieu of heated valve enclosures to protect the dry pipe valve and supply pipe against freezing. [13:8.2.5.2.3]

5.2.1.3.3 High Water Level Protection.

5.2.1.3.3.1 Where it is possible to reseal the dry valve after actuation without first draining the system, protection against occurrence of water above the clapper shall be permitted in accordance with 5.2.1.3.3.3. [13:8.2.5.4.1]

Δ 5.2.1.3.3.2 Differential Dry Pipe Valve. Protection against accumulation of water above the clapper shall be provided for differential dry pipe valves in accordance with 5.2.1.3.3.3. [13:8.2.5.4.2]

5.2.1.3.3.3 High Water Level Device. An automatic high water level signaling device or an automatic drain device shall be permitted. [13:8.2.5.4.3]

5.2.1.4 Air Pressure and Supply. [13:8.2.6]

5.2.1.4.1 Maintenance of Air Pressure. Air or nitrogen or other approved gas pressure shall be maintained on dry pipe systems throughout the year. [13:8.2.6.2]

5.2.1.4.2* Air Supply. [13:8.2.6.3]

5.2.1.4.2.1 The compressed air supply shall be from a source available at all times. [13:8.2.6.3.1]

5.2.1.4.2.2* The air supply shall have a capacity capable of restoring normal air pressure in the system within 30 minutes. [13:8.2.6.3.2]

5.2.1.4.3 Air Supply Connection. [13:8.2.6.4]

5.2.1.4.3.1 The connection from the air supply to the dry pipe valve shall not be less than ½ in. (15 mm) in diameter and shall enter the system above the priming water level of the dry pipe valve. [13:8.2.6.4.1]

Δ 5.2.1.4.3.2 A check valve shall be installed in the air filling connection. [13:8.2.6.4.2]

N 5.2.1.4.3.3 A listed or approved shutoff valve of either the renewable disc type or ball valve type shall be installed on the supply side of this check valve. [13:8.2.6.4.2.1]

5.2.1.4.4 Relief Valve. An approved relief valve shall be provided between the air supply and the shutoff valve and shall be set to relieve pressure no less than 10 psi (0.7 bar) in excess of system air pressure provided in 5.2.1.4.10 and shall not exceed the manufacturer's limitations. [13:8.2.6.5]

5.2.1.4.5 Automatic Air Maintenance. Unless the requirements of 5.2.1.4.6 are met, where the air supply to a dry pipe system is maintained automatically, the air supply shall be from a dependable plant system or an air compressor with an air receiver, and shall utilize an air maintenance device specifically listed for such service and capable of controlling the required air pressure on, and maximum airflow to, the dry system. [13:8.2.6.6.1]

5.2.1.4.6 Where the air compressor supplying the dry pipe system has a capacity less than 5.5 ft³/min (160 L/min) at 10 psi (0.7 bar), an air receiver or air maintenance device shall not be required. [13:8.2.6.6.2]

5.2.1.4.7 The automatic air supply to more than one dry pipe system shall be connected to enable individual maintenance of air pressure in each system. [13:8.2.6.6.3]

5.2.1.4.8 A check valve or other positive backflow prevention device shall be installed in the air supply to each system to prevent airflow or waterflow from one system to another. [13:8.2.6.6.4]

5.2.1.4.9 System Air Pressure.

5.2.1.4.10 The system air pressure shall be maintained in accordance with the instruction sheet furnished with the dry pipe valve, or shall be 20 psi (1.4 bar) in excess of the calculated trip pressure of the dry pipe valve, based on the highest normal water pressure of the system supply. [13:8.2.6.7.1]

5.2.1.4.11 The permitted rate of air leakage shall be as specified in 5.2.1.4.12. [13:8.2.6.7.2]

5.2.1.4.12 In addition to the standard hydrostatic test, an air pressure leakage test at 40 psi (2.7 bar) shall be conducted for 24 hours. Any leakage that results in a loss of pressure in excess of 1½ psi (0.1 bar) for the 24 hours shall be corrected. [13:8.2.6.7.3]

5.2.1.4.13 Nitrogen. Where used, nitrogen shall be introduced through a pressure regulator set to maintain system pressure in accordance with 5.2.1.4.5.

5.2.2 Auxiliary Systems. A wet standpipe system shall be permitted to supply an auxiliary dry standpipe system, provided the water supply is capable of supplying the system demand.

5.2.3* Semiautomatic Dry.

5.2.3.1 A listed remote control activation device shall be provided at each hose connection within 3 ft (1 m) and shall be visible and identified as to its intended use and in accordance with the manufacturer's specifications.

5.2.3.1.1 The remote control activation device shall be permitted to be secured in an approved manner to prevent unauthorized system activation.

5.2.3.1.2 The remote control activation system shall be installed in accordance with *NFPA 72*.

5.2.3.1.3* The remote control activation circuits shall be protected from mechanical damage.

5.2.3.1.4 All wiring for actuation of semiautomatic systems shall be supervised in accordance with *NFPA 72*.

5.2.3.2 All remote control activation devices of the semiautomatic dry standpipe system shall be compatible and listed for the intended use.

5.2.3.3 The automatic water control valve shall be provided with hydraulic means or mechanical manual means for operation that is independent of the remote control activation device.

5.2.3.4 Pressure Gauges. Approved pressure gauges conforming with Section 5.5 shall be installed as follows:

- (1) Above and below preaction valve and below deluge valve
- (2) On air supply to preaction and deluge valves

[13:8.3.1.3]

5.2.3.5 Location and Protection of System Water Control Valves. [13:8.3.1.8]

5.2.3.5.1 System water control valves and supply pipes shall be protected against freezing and mechanical injury. [13:8.3.1.8.1]

5.2.3.5.2 Valve Rooms. [13:8.3.1.8.2]

5.2.3.5.2.1 Valve rooms shall be lighted and heated. [13:8.3.1.8.2.1]

5.2.3.5.2.2 The source of heat shall be of a permanently installed type. [13:8.3.1.8.2.2]

5.2.3.5.2.3 Heat tracing shall not be used in lieu of heated valve enclosure rooms to protect preaction and deluge valves and supply pipe against freezing. [13:8.3.1.8.2.3]

5.2.3.6 Semiautomatic dry systems shall be one of the following types:

- (1) A single interlock system, which admits water to piping upon operation of the remote control activation device
- (2) A non-interlock system, which admits water to piping upon operation of remote control activation device or hose valve
- (3) A double interlock system, which admits water to piping upon operation of both remote control activation devices and hose valves

5.3 Classes of Standpipe Systems.

5.3.1 Class I Systems. A Class I standpipe system shall provide 2½ in. (65 mm) hose connections to supply water for use by fire departments and those trained in handling heavy fire streams.

5.3.2 Class II Systems.

5.3.2.1 A Class II standpipe system shall provide either 1½ in. (40 mm) hose stations to supply water for use by trained personnel or a hose connection for the fire department during initial response.

5.3.2.2 A minimum 1 in. (25.4 mm) hose shall be permitted to be used for hose stations in light hazard occupancies where investigated and listed for this service and where approved by the AHJ.

5.3.3 Class III Systems. A Class III standpipe system shall provide 1½ in. (40 mm) hose stations to supply water for use by trained personnel and 2½ in. (65 mm) hose connections to

supply a larger volume of water for use by fire departments and those trained in handling heavy fire streams.

5.3.3.1 A minimum 1 in. (25.4 mm) hose shall be permitted to be used for hose stations in light hazard occupancies where investigated and listed for this service and where approved by the AHJ.

5.3.3.2 Where the building is protected throughout by an approved automatic sprinkler system, Class II hose stations for use by trained personnel shall not be required, subject to the approval of the AHJ, provided that each Class I hose connection is 2½ in. (65 mm) and is equipped with a 2½ in. × 1½ in. (65 mm × 40 mm) reducer and a cap attached with a chain.

5.3.3.2.1 Class III standpipes meeting the provisions of 5.3.3.2 shall not be required to meet the pressure requirements of 7.2.3.1 or the travel requirements of 7.3.3.

5.4* Required Type of System.

5.4.1 Class I Standpipe Systems.

5.4.1.1* Class I standpipe systems shall be permitted to be automatic dry, automatic wet, semiautomatic dry, manual dry, or manual wet in buildings not classified as high-rise buildings.

5.4.1.2 Class I standpipe systems in buildings classified as high-rise buildings shall be automatic or semiautomatic.

N 5.4.1.2.1 Manual standpipes shall be permitted in open parking garages where the highest floor is located not more than 150 ft (45,720 mm) above the lowest level of fire department vehicle access.

5.4.1.2.2 In buildings classified as high-rise, all required standpipes shall be automatic or semiautomatic, including partial height and horizontal standpipes that serve only a portion or limited number of floors within the building.

5.4.1.3 Where an existing standpipe system having standpipes with a minimum diameter of 4 in. (100 mm) is to be utilized to supply a new retrofit sprinkler system, the water supply required by Sections 7.8 and 7.10 shall not be required to be provided by automatic or semiautomatic means, provided that the water supply is adequate to supply the hydraulic demand of the sprinkler system in accordance with *NFPA 13*.

5.4.1.4 Class I standpipe systems shall be wet systems except where piping is subject to freezing.

5.4.2 Class II and Class III Standpipe Systems. Class II and Class III standpipe systems with 1½ in. (40 mm) hose stations shall be automatic wet systems unless located in a facility where piping is subject to freezing and where a fire brigade is trained to operate the system without fire department intervention, in which case an automatic dry or semiautomatic dry system shall be permitted.

5.4.2.1* In a non-high-rise building, the Class I portion of a Class III system shall be permitted to be manual. The Class II portion of a Class III system shall be automatic.

5.5* Gauges.

5.5.1 An approved pressure gauge with a connection not smaller than ¼ in. (6 mm) shall be installed at each discharge pipe from the fire pump and the public waterworks, at the pressure tank, at each main drain connection, at the air pump supplying the pressure tank, and at the top of each standpipe.

5.5.1.1 Gauges shall be located to permit removal and shall be located where they will not be subject to freezing.

5.5.1.2 Each gauge connection shall be equipped with a shut-off valve and provisions for draining.

5.5.1.3 Where several standpipes are interconnected at the top, a single gauge shall be permitted to be substituted for a gauge at the top of each standpipe.

5.5.1.4 Pressure gauges shall be installed above and below each alarm check valve, dry pipe valve, deluge valve, backflow preventer, or system riser check valve where such devices are present.

5.5.2* Pressure-Regulating Device.

5.5.2.1 A valved outlet for a pressure gauge shall be installed on the upstream side of every pressure-regulating device.

5.5.2.2 Approved pressure gauges shall be installed on both upstream and downstream sides of every pressure-regulating device installed in accordance with 7.2.4(6).

5.6* Waterflow and Supervisory Alarms.

5.6.1 Except for manual dry and manual wet standpipe systems, listed waterflow devices shall be provided for each standpipe system.

5.6.2 Waterflow alarms shall utilize a sensing mechanism appropriate to the type of standpipe.

5.6.3 Paddle-type waterflow alarms shall be used on wet standpipe systems only.

5.6.4* A means for testing the waterflow device shall be provided.

5.6.5 Alarm and supervisory devices shall be installed in accordance with *NFPA 72*.

Chapter 6 Installation Requirements

6.1* Location and Protection of Piping.

6.1.1 **Location of Dry Standpipes.** Dry standpipes shall be monitored in accordance with *NFPA 72* with supervisory air pressure.

6.1.2 Protection of Aboveground Piping.

6.1.2.1* Standpipe system piping shall be protected from mechanical damage and fire damage in accordance with this section.

6.1.2.2* Standpipe systems shall be protected in accordance with Table 6.1.2.2.

6.1.2.2.1 Protection shall consist of one of the following methods:

- (1) Enclosure in a fire-rated exit stairway
- (2) Enclosure in fire-rated construction with such rating equal to that of the enclosed fire rated exit stairway
- (3) Listed fire wrap or other insulating material applied directly to the pipe with such rating equal to that of the enclosed fire-rated exit stairway

6.1.2.2.2 Where exit stairways are not required to be enclosed in fire-rated construction, standpipe systems shall not be required to be protected.

6.1.2.2.3 Class II standpipe systems are not required to be protected.

6.1.2.2.4 Where additional standpipes are needed to meet travel distance requirements in non-high-rise buildings, protection of piping is not required.

6.1.2.2.5 Piping subject to mechanical damage shall be protected by steel posts, concrete barriers, or other approved means.

6.1.2.3 Where standpipe system piping that is normally filled with water passes through an area subject to freezing temperatures, it shall be protected to maintain the temperature of the water in the piping between 40°F and 120°F (4°C and 48.9°C).

6.1.2.3.1 Antifreeze solutions shall not be used to protect standpipe system piping from freezing.

6.1.2.3.2 Listed heat tracing shall be permitted to be used for protection from freezing.

6.1.2.3.2.1 Heat tracing shall be installed and insulated in accordance with the manufacturer's specifications.

6.1.2.3.2.2* Where heat tracing is utilized, it shall be specifically listed for use on fire suppression systems.

Δ Table 6.1.2.2 Protection of Aboveground Piping

Construction Type	Sprinkler Protection	High-Rise Buildings			Non-High-Rise Buildings		
		Standpipe	Horizontal ^a	Branchline	Standpipe	Horizontal ^a	Branchline
I	AS ^b	✓	N/A	N/A	✓	N/A	N/A
I	NS ^c	✓	✓	✓	✓	N/A	N/A
II	AS	✓	N/A	N/A	✓	N/A	N/A
II	NS	✓	✓	✓	✓	N/A	N/A
III, IV, & V	AS/NS	✓	✓	✓	✓	N/A	N/A

Notes:

^aRefers to either a horizontal standpipe or the horizontal portion of any standpipe such as a feed main.

^bAS = fully sprinklered building in accordance with *NFPA 13*

^cNS = nonsprinklered or partially sprinklered building

6.1.2.3.2.3 Where heat tracing systems are used, they shall be supervised by one of the following methods:

- (1) Central station, proprietary, or remote station signaling service
- (2) Local signaling service that will cause a signal at a constantly attended location

N 6.1.2.3.3 Water-filled piping shall be permitted to be installed in areas where the temperature is less than 40°F (4°C) when heat loss calculations performed by a professional engineer verify that the system will not freeze.

6.1.2.4 Where corrosive conditions exist or piping is exposed to the weather, corrosion-resistant types of pipe, tube, fittings, and hangers or protective corrosion-resistive coatings shall be used.

6.1.2.5 Where standpipe systems are required to be protected against damage from earthquakes, standpipe systems shall be protected in accordance with NFPA 13.

6.1.3 Horizontal piping for all dry standpipe systems and semi-automatic standpipes shall be pitched to drain at least ¼ in. per 10 ft (2 mm/m).

6.1.4 In refrigerated areas, the pipe shall be pitched to drain at least ½ in. per 10 ft (4 mm/m).

6.2 Underground Piping. Underground piping shall be in accordance with NFPA 24.

6.3 Gate Valves and Check Valves.

6.3.1 Connection to Water Supply.

6.3.1.1 Connections to each automatic water supply shall be provided with an approved indicating-type valve and check valve located close to the supply.

6.3.1.1.1 The approved indicating-type valve and check valve shall be permitted to be located within the building.

6.3.1.2 Valves in 6.3.1.1 shall not be required for automatic and semiautomatic standpipe systems supplied by fire pumps.

6.3.1.3 Backflow preventers shall be acceptable devices to meet the requirements of 6.3.1.1.

6.3.1.4 Valves in 6.3.1.1 shall not be required on manual dry standpipe systems.

6.3.1.4.1 The valves required by 6.3.2 shall be provided where there is more than one standpipe on a system.

6.3.1.5* An approved indicating-type valve and approved check valve shall be provided in the water supply for a manual wet standpipe system.

6.3.2 Valves shall be provided on all standpipes, including manual dry standpipes and horizontal standpipes, to allow isolation of a standpipe without interrupting the supply to other standpipes from the same source of supply.

6.3.3 Listed indicating-type valves shall be provided at the standpipe for controlling branch lines where the distance to the remote hose connection exceeds 40 ft (12 m) measured along the pipe.

6.3.4 Where wafer-type valve discs are used, they shall be installed so that they do not interfere with the operation of other system components.

6.3.5* Control Valves and Check Valves on Combined (Standpipe/Sprinkler) Systems.

6.3.5.1 Each connection from a standpipe that is part of a combined system to a sprinkler system shall have an individual control valve and check valve.

6.3.5.2 A listed pressure-regulating device that prevents back-flow shall be considered a check valve, and an additional check valve shall not be required.

6.3.6 Valves on Connections to Water Supplies.

6.3.6.1 General.

6.3.6.1.1* Each water supply, other than the fire department connection, shall be provided with a listed indicating valve in an approved location.

6.3.6.1.2 Valves on fire department connections shall be in accordance with Sections 6.3 and 6.4.

6.3.6.1.2.1 All valves shall be plainly marked to indicate the service that they control.

6.3.6.1.2.2 The indicating valve shall be installed where it is readily accessible in case of fire and not subject to damage.

6.3.6.1.2.3 Wall post indicator valves shall be permitted where approved by the AHJ.

6.3.6.1.3 Where a post-indicator valve cannot be used, an underground valve with an approved roadway box, complete with T-wrench, shall be permitted.

6.3.6.1.3.1 The location of the T-wrench shall be acceptable to the AHJ.

6.3.6.1.3.2 The valve locations, directions for their opening, and services that they control shall be plainly marked on the buildings served.

6.3.7 Valve Supervision.

6.3.7.1 System water supply valves, isolation control valves, and other valves in feed mains shall be supervised in an approved manner in the open position by one of the following methods:

- (1) A central station, proprietary, or remote station signaling service
- (2) A local signaling service that initiates an audible signal at a constantly attended location
- (3) Locking of valves in the open position
- (4) Sealing of valves and an approved weekly recorded inspection where valves are located within fenced enclosures under the control of the owner

6.3.7.2 Underground gate valves with roadway boxes shall not be required to be supervised.

6.3.7.3 The bypass valves required in 7.2.4(4) shall be supervised in the closed position.

6.3.7.3.1 Supervision of these valves shall be in accordance with 6.3.7.1(1) or 6.3.7.1(2).

6.3.8 Signs for Room Identification, Valves, and Hose Connections.

6.3.8.1 All main and sectional system control valves, including water supply control valves, shall have a sign indicating the portion of the system that is controlled by the valve.

6.3.8.2 All control, drain, and test connection valves shall be provided with signs indicating their purpose.

6.3.8.3 Where sprinkler system piping supplied by a combined system is supplied by more than one standpipe ("loop" or "dual feed" design), a sign shall be located at each dual or multiple feed connection to the combination system standpipe to indicate that in order to isolate the sprinkler system served by the control valve, an additional control valve or valves at other standpipes shall be shut off.

6.3.8.3.1 The sign also shall identify the location of the additional control valves.

6.3.8.4 Where a main or sectional system control valve is located in a closed room or concealed space, the location of the valve shall be indicated by a sign in an approved location on the outside of the door or near the opening to the concealed space.

Δ 6.3.8.5* Where hose connections are not located in exit stairways, signs shall be provided in accordance with NFPA 170 to identify the location of the hose connection in an approved manner.

6.3.8.5.1 Valve cabinets, where provided, shall be marked to indicate the contents.

6.3.8.5.2 Letters shall be red with a white background and shall be 2½ in. (65 mm) in height.

6.4* Fire Department Connections.

6.4.1 Isolation valves shall not be permitted between the fire department connection and where the fire department connection piping connects to the system piping.

6.4.2 A listed check valve shall be installed in each fire department connection and shall be located in an accessible location. [13:16.12.6.1]

6.4.2.1 The check valve shall be installed as close as possible to the fire department connection inlets.

6.4.2.1.1 The check valve shall be located where it is not subjected to freezing conditions.

6.4.2.2 The requirements of 6.4.2 shall apply to manual dry systems.

6.4.3 The fire department connection shall be installed as follows:

- (1) *Automatic wet and manual wet standpipe systems.* On the system side of the system control valve, check valve, or any pump, but on the supply side of any isolating valves required by 6.3.2
- (2) *Automatic dry standpipe systems.* On the system side of the control valve and check valve and the supply side of the dry pipe valve
- (3) *Semiautomatic dry standpipe systems.* On the system side of the deluge valve
- (4) *Manual dry standpipe systems.* Directly connected to system piping with a check valve in the piping as required by 6.4.2

6.4.3.1 Fire department connections shall not be connected on the suction side of fire pumps. [13:16.12.5.9]

6.4.4* In areas subject to freezing, an approved automatic drip valve that is arranged to allow drainage without causing

water damage shall be installed at the low point in the piping between the check valve and the fire department connection.

6.4.5 Location and Identification.

6.4.5.1 Fire department connections shall be visible and recognizable from the street or nearest point of fire department apparatus accessibility or on the street side of buildings.

6.4.5.1.1 Fire department connections shall be located and arranged so that hose lines can be attached to the inlets without interference from nearby objects, including buildings, fences, posts, landscaping, vehicles, or other fire department connections.

6.4.5.2 Each fire department connection shall be designated by a sign, with letters at least 1 in. (25.4 mm) in height, that reads "STANDPIPE." For manual systems, the sign shall also indicate that the system is manual and that it is either wet or dry.

6.4.5.2.1 If automatic sprinklers are also supplied by the fire department connection, the sign or combination of signs shall indicate both designated services (e.g., "STANDPIPE AND AUTOSPKR" or "AUTOSPKR AND STANDPIPE").

6.4.5.2.2 A sign also shall indicate the pressure required at the inlets to deliver the standpipe system demand.

N 6.4.5.2.2.1 The pressure required sign shall not be required when the pressure required is 150 psi (10.3 bar) or less.

6.4.5.3 Where a fire department connection services multiple buildings, structures, or locations, a sign shall be provided indicating the buildings, structures, or locations served.

6.4.5.4* Fire department connections shall be located not more than 100 ft (30.5 m) from the nearest fire hydrant connected to an approved water supply.

6.4.5.4.1 The location of the fire department connection shall be permitted to exceed 100 ft (30.5 m) subject to the approval of the AHJ.

6.4.6 Fire department connections shall be located not less than 18 in. (457 mm) nor more than 48 in. (1219 mm) above the level of the adjoining ground, sidewalk, or grade surface.

6.4.7 Fire department connection piping shall be supported in accordance with Section 6.5.

6.5 Support of Piping. Support of system piping shall be in accordance with NFPA 13.

6.6 Installation of Signs. Signs shall be secured to a device or the building wall with corrosion-resistant chains or fasteners.

6.7 Signs for Water Supply Pumps. Where a fire pump is provided, a sign shall be located in the vicinity of the pump indicating the minimum pressure and flow required at the pump discharge flange to meet the system demand.

6.8* Hydraulic Design Information Sign.

6.8.1 The installing contractor shall provide a sign identifying the basis of the system design.

6.8.2 The sign shall be located at the water supply control valve for automatic or semiautomatic standpipe systems and at an approved location for manual systems.

6.8.3 The sign shall indicate the following:

- (1) Location of the two hydraulically most remote hose connections
- (2) Design flow rate for the connections identified in 6.8.3(1)
- (3) Design residual inlet and outlet pressures for the connections identified in 6.8.3(1)
- (4) Design static pressure and the design system demand (i.e., flow and residual pressure) at the system control valve, or at the pump discharge flange where a pump is installed, and at each fire department connection

Chapter 7 Design

7.1* General. The design of the standpipe system is governed by building height, area per floor occupancy classification, egress system design, required flow rate and residual pressure, and the distance of the hose connection from the source(s) of the water supply.

7.1.1* When pressure-regulating devices are used, they shall be approved for installation within the maximum and minimum anticipated flow conditions.

7.2* Pressure Limitation.

7.2.1 The maximum pressure at any point in the system at any time shall not exceed **400 psi (28 bar)**.

7.2.2 Express mains supplying higher standpipe zones shall be permitted to be designed with pressures in excess of **400 psi (28 bar)** in accordance with their materials listings or as approved by the AHJ.

7.2.2.1 Where express mains supply higher standpipe zones, there shall be no hose valves on any portion of the system where the pressure exceeds **400 psi (28 bar)**.

7.2.3* Maximum Pressure at Hose Connections.

Δ 7.2.3.1 Where the residual pressure at a 1½ in. (40 mm) hose connection available for trained personnel use exceeds 100 psi (6.9 bar), a listed pressure-regulating device shall be provided to limit residual pressure at the flow required by Section 7.10 to 100 psi (6.9 bar).

7.2.3.1.1 Paragraph 7.2.3.1 shall not apply to the 1½ in. (40 mm) outlet on a 2½ in. × 1½ in. (65 mm × 40 mm) reducer as allowed by 5.3.3.2 and 7.3.4.1.

N 7.2.3.1.2 Paragraph 7.2.3.1 shall not apply to the 1½ in. (40 mm) hose connection when there is no hose required.

N 7.2.3.1.3 Where the static pressure at a 1½ in. (40 mm) hose connection exceeds 175 psi (12.1 bar), a listed pressure-regulating device shall be provided to limit static and residual pressures at the hose connection to no more than 175 psi (12.1 bar).

Δ 7.2.3.2* Where the static pressure at a 2½ in. (65 mm) hose connection exceeds 175 psi (12.1 bar), a listed pressure-regulating device shall be provided to limit static and residual pressures at the hose connection to no more than 175 psi (12.1 bar).

7.2.3.2.1 Where a listed pressure regulating device is not manufactured, the AHJ shall be permitted to approve a nonlisted device.

7.2.3.3 The pressure on the inlet side of the pressure-regulating device shall not exceed the rated working pressure of the device.

7.2.4* Where more than two hose connections are used downstream of a pressure-regulating device, the following conditions shall apply:

- (1) In systems with multiple zones, pressure-regulating device(s) shall be permitted to be used in lieu of providing separate pumps to control pressure in the lower zone(s) as long as the devices comply with all requirements in 7.2.4.
- (2) A method to isolate the pressure-regulating device(s) shall be provided for maintenance and repair.
- (3) **To provide redundancy, pressure-regulating devices shall be arranged in series so that the failure of any single device does not allow pressure in excess of 175 psi (12.1 bar) to any of the multiple hose connections downstream.**
- (4) An equally sized bypass around the pressure-regulating device(s), with a normally closed control valve, shall be installed.
- (5) Pressure-regulating device(s) shall be installed not more than 7 ft 6 in. (2.31 m) above the floor.
- (6) The pressure-regulating device shall be provided with inlet and outlet pressure gauges.
- (7) The fire department connection(s) shall be connected to the system side of the outlet isolation valve.
- (8) The pressure-regulating device shall be provided with a pressure relief valve in accordance with the manufacturer's recommendations.
- (9) Remote monitoring and supervision for detecting high pressure failure of the pressure-regulating device shall be provided in accordance with *NFPA 72*.

7.3 Locations of Hose Connections.

7.3.1* General.

7.3.1.1 Hose connections and hose stations shall be unobstructed and shall be located not less than 3 ft (0.9 m) or more than 5 ft (1.5 m) above the floor.

7.3.1.1.1 This dimension shall be measured from the floor to the center of the hose valve.

7.3.1.2 The hose connection shall not be obstructed by any closed or open stairwell door(s) or other objects on the landing.

7.3.2* Class I Systems. Where required to be provided, hose connections shall be located in accordance with 7.3.2.

7.3.2.1 Hose connections shall be provided at each main floor landing of required exit stairs.

7.3.2.1.1* Where required by the AHJ or local fire department, hose connections shall be permitted to be installed at the highest intermediate floor landings between floor levels in required exit stairs.

7.3.2.2* Hose connections shall be provided on each side of the wall adjacent to the exit openings of horizontal exits.

7.3.2.2.1* Where all floor areas are reachable from an exit stairway hose connection on the same side of a horizontal exit within the distances required by 7.3.2.2.1.1 or 7.3.2.2.1.2 as applicable, the hose connection on the other side of the horizontal exit shall be permitted to be omitted.

7.3.2.2.1.1 The travel distance in 7.3.2.2.1 shall be 200 ft (61 m) for sprinklered buildings.

7.3.2.2.1.2 The travel distance in 7.3.2.2.1 shall be 130 ft (39.7 m) for nonsprinklered buildings.

7.3.2.3 Hose connections shall be provided in each exit passageway in other than covered mall buildings.

7.3.2.3.1 The hose connections required in 7.3.2.3 shall be located in the exit passageway at each entrance to the building.

7.3.2.4 Nonrequired stairs connecting two adjacent floors shall not require hose connections.

Δ 7.3.2.5* A single hose connection shall be permitted to be installed in the open corridor between open stairs that are not greater than 75 ft (23 m) apart.

7.3.2.6 Hose connections shall be provided in covered mall buildings, at the entrance to each exit passageway or exit corridor, and at the interior side of public entrances from the exterior to the mall.

7.3.2.7* Hose connections shall be provided at the highest landing of stairways with stairway access to a roof.

7.3.2.8* The hose connection required by 7.3.2.7 shall not be required where hose connections are installed in accordance with 7.3.2.1.1.

7.3.2.9 In stairways that do not access the roof, a hose connection shall be provided on the roof.

7.3.2.9.1 The hose connection required by 7.3.2.9 shall not be required where the roof slope is 4 in 12 or greater.

7.3.2.9.2 The hose connection required by 7.3.2.9 shall not be required where at least one hose connection in accordance with 7.3.2.7 is provided in the building.

7.3.2.9.2.1 Where there are no hose connections as provided by 7.3.2.9.2, a single hose connection shall be provided on the roof.

7.3.2.10* Additional hose connections shall be provided in unsprinklered buildings where the distance from connections required by 7.3.2.1 through 7.3.2.3 to the most remote portion or story exceeds 150 ft (45.7 m).

7.3.2.11* Additional hose connections shall be provided in buildings sprinklered in accordance with NFPA 13 or NFPA 13R where the distance from connections required by 7.3.2.1 through 7.3.2.3 to the most remote portion or story exceeds 200 ft (61 m).

7.3.2.11.1 The distance in 7.3.2.10 and 7.3.2.11 shall be measured from the hose connection.

7.3.2.11.2 The location of additional hose connections shall be approved by the AHJ.

7.3.2.11.3 The distance in 7.3.2.10 and 7.3.2.11 shall not apply to the roof if the roof is not intended for occupancy.

7.3.2.11.4 Where allowed by the AHJ, the hose connections required by 7.3.2.11 shall be permitted to be omitted.

Δ 7.3.2.12 In open parking garages, the distances in 7.3.2.10 and 7.3.2.11 shall be reduced to 130 ft (39.7 m) when manual dry standpipes are installed.

7.3.3* Class II Systems.

7.3.3.1 Class II systems shall be provided with 1½ in. (40 mm) hose stations so that all portions of each floor level of the building are within 130 ft (39.7 m) of a hose connection provided with 1½ in. (40 mm) hose or within 120 ft (36.6 m) of a hose connection provided with less than 1½ in. (40 mm) hose.

7.3.3.2 Distances shall be measured along a path of travel originating at the hose connection.

7.3.4 Class III Systems. Class III systems shall be provided with hose connections as required for both Class I and Class II systems.

7.3.4.1 Where a building is protected throughout by an approved automatic sprinkler system in accordance with NFPA 13 or NFPA 13R, Class II hose stations for use by trained personnel shall not be required provided that each Class I hose connection is 2½ in. (65 mm) and is equipped with a 2½ in. × 1½ in. (65 mm × 40 mm) reducer and a cap attached with a chain.

7.3.4.1.1 The travel distance limitation of 7.3.3.1 shall not apply to Class III systems.

7.3.4.1.2 For Class III systems installed without hose, the flow, pressure, and duration requirements shall be as specified for Class I systems in buildings protected throughout by an approved automatic sprinkler system.

7.4 Number of Standpipes. Separate standpipes shall be provided in each required exit stairway.

7.5* Interconnection of Standpipes.

7.5.1 Where two or more standpipes are installed in the same building or section of building, they shall be interconnected.

N 7.5.1.1 Standpipes shall be permitted to not be interconnected where acceptable to the AHJ.

7.5.2 Where standpipes are supplied by tanks located at the top of the building or zone, the standpipes shall be interconnected at the top.

7.5.3 Where wet standpipes are interconnected at the top and bottom, check valves shall be installed at the base of each standpipe to prevent circulation.

7.5.4 Dry standpipes shall have only a single level of interconnection.

7.6 Minimum Sizes for Standpipes and Branch Lines, Class I and Class III Standpipes.

7.6.1 Standpipes shall be at least 4 in. (100 mm) in size.

7.6.2 Standpipes that are part of a combined system in a building that is partially sprinklered shall be at least 6 in. (150 mm) in size.

7.6.3 Where the building is protected throughout by an approved automatic sprinkler system in accordance with NFPA 13 or NFPA 13R, the minimum combined standpipe size shall be 4 in. (100 mm) for systems hydraulically designed in accordance with 7.8.1.

Δ 7.6.4 Branch lines shall be sized based on the hydraulic criteria established in Sections 7.8 and 7.10 but not sized smaller than 2½ in. (65 mm).

7.7 System Design and Sizing of Pipe for Delivery of System Demand.

7.7.1 Class I and Class III standpipe systems shall be designed so that the system demand can be supplied by each fire department connection, which is provided in accordance with Section 7.12.

7.7.2* Where an automatic or semiautomatic water supply is required for a Class I, II, or III standpipe system by Section 5.4, the standpipe system shall be designed so that the system demand can be independently supplied by the attached water supply and each fire department connection provided on the system.

7.7.3 Where a manual system is permitted by Section 5.4 and an attached water supply is provided to supply an automatic sprinkler system or to maintain water in a wet system, the attached water supply shall not be required to satisfy the standpipe system demand.

7.7.4 When the system demand to be supplied by the fire department at the fire department connection is being determined, the local fire department shall be consulted regarding the water supply available from a fire department pumper.

7.8* Minimum and Maximum Pressure Limits.

Δ 7.8.1 **Minimum Design Pressure for Hydraulically Designed Systems.** Hydraulically designed standpipe systems shall be designed to provide the waterflow rate required by Section 7.10 at a minimum residual pressure of 100 psi (6.9 bar) at the hydraulically most remote 2½ in. (65 mm) hose connection and 65 psi (4.5 bar) at the outlet of the hydraulically most remote 1½ in. (40 mm) hose connection.

7.8.1.1 The pressure loss through the hose valve shall be determined using the valve manufacturer's most up-to-date friction loss data.

7.8.1.1.1 The values in Table 8.3.1.3 shall be permitted to be used for non-pressure-reducing valves when the valve manufacturer's most up-to-date friction loss data is unavailable.

7.8.1.2* Manual standpipe systems shall be designed to provide 100 psi (6.9 bar) at the outlet of the hydraulically most remote 2½ in. (65 mm) hose connection valve with the calculations terminating at the fire department connection.

N 7.8.1.2.1 The pressure required at the fire department connection for manual standpipes shall not exceed the working pressure of the system components of the standpipe system or sprinkler system when the system is a combined system.

7.9* Standpipe System Zones.

7.9.1 Except as permitted by 7.2.4, each standpipe system zone shall be provided with a separate pump or a separate discharge outlet from a multiple-stage, multiple-port fire pump.

7.9.1.1 The use of pumps arranged in series to meet the requirements of 7.9.1 shall be permitted.

7.9.1.2 Pumps that are arranged in series shall be permitted to be, but are not required to be, located on the same level.

7.9.2* Each zone above the low zone shall have two or more separate and direct supply pipes sized to automatically and independently supply the flow and pressure requirements of Sections 7.8 and 7.10.

7.9.2.1 Standpipes from the lower zone shall be permitted to be used to meet the requirements of 7.9.2.

7.9.3* For buildings with two or more zones in which any portion of the higher zones cannot be supplied by means of fire department pumpers through a fire department connection, an auxiliary means of supply in the form of high-level water storage with additional pumping equipment or other means acceptable to the AHJ shall be provided.

7.10 Flow Rates.

7.10.1 Class I and Class III Systems.

7.10.1.1* Flow Rate.

7.10.1.1.1 For Class I and Class III systems, the minimum flow rate for the hydraulically most remote standpipe shall be 500 gpm (1893 L/min), through the two most remote 2½ in. (65 mm) hose connections, and the calculation procedure shall be in accordance with 7.10.1.2.

7.10.1.1.2* Where a horizontal standpipe on a Class I or Class III system supplies three or more hose connections on any floor, the minimum flow rate for the hydraulically most demanding horizontal standpipe shall be 750 gpm (2840 L/min), and the calculation procedure shall be in accordance with 7.10.1.2.2.

7.10.1.1.3 The minimum flow rate for additional standpipes shall be 250 gpm (946 L/min) per standpipe for buildings with floor areas that do not exceed 80,000 ft² (7432 m²) per floor.

7.10.1.1.3.1 For buildings that exceed 80,000 ft² (7432 m²) per floor, the minimum flow rate for additional standpipes shall be 500 gpm (1893 L/min) for the second standpipe and 250 gpm (946 L/min) for the third standpipe if the additional flow is required for an unsprinklered building.

7.10.1.1.4 Flow rates for combined systems shall be in accordance with 7.10.1.3.

7.10.1.1.5 The maximum flow rate shall be 1000 gpm (3785 L/min) for buildings that are sprinklered throughout, in accordance with NFPA 13, and 1250 gpm (4731 L/min) for buildings that are not sprinklered throughout, in accordance with NFPA 13.

7.10.1.1.6* Where lateral piping serves a single hose connection, the minimum flow rate for the system shall be determined as if the hose connection is being served from a separate standpipe.

7.10.1.2* Hydraulic Calculation Requirements.

7.10.1.2.1 Hydraulic calculations and pipe sizes for each standpipe shall be based on providing 250 gpm (946 L/min) at the two hydraulically most remote hose connections on the standpipe and at the connection point of each of the other standpipes at the minimum residual pressure required by Section 7.8.

7.10.1.2.1.1* Where a standpipe system has risers that terminate at different floor levels, separate hydraulic calculations shall be performed for the standpipes that exist on each level.

7.10.1.2.1.2 In each case, flow shall be added only for standpipes that exist on the floor level of the calculations.

7.10.1.2.2 Where a horizontal standpipe on a Class I and Class III system supplies three or more hose connections on

any floor, hydraulic calculations and pipe sizes for each standpipe shall be based on providing 250 gpm (946 L/min) at the three hydraulically most remote hose connections on the standpipe and at the connection point of each of the other standpipes at the minimum residual pressure required by Section 7.8.

7.10.1.2.3* Common supply piping shall be calculated and sized to provide the required flow rate for all standpipes connected to such supply piping, with the total not to exceed the maximum flow demand in 7.10.1.1.5.

7.10.1.2.3.1* Common supply piping for separate standpipe systems shall be calculated to provide flow for the most demanding system.

7.10.1.2.4 Flows from additional standpipes as required by 7.10.1.1 shall not be required to be balanced to the higher pressure at the point of connection.

7.10.1.3 Combined Systems.

7.10.1.3.1 For a building protected throughout by an approved automatic sprinkler system, the system demand established by Section 7.7 and 7.10.1 also shall be permitted to serve the sprinkler system.

7.10.1.3.1.1 In a building protected in accordance with NFPA 13 or NFPA 13R, the water supply for the combined sprinkler and automatic standpipe system shall be based on the sprinkler system demand (including any hose stream demand) or the standpipe demand, whichever is greater.

7.10.1.3.1.2 A separate sprinkler demand shall not be required.

7.10.1.3.2 For a combined system in a building equipped with partial automatic sprinkler protection, the flow rate required by 7.10.1 shall be increased by an amount equal to the hydraulically calculated sprinkler demand or 150 gpm (568 L/min) for light hazard occupancies, or by 500 gpm (1893 L/min) for ordinary hazard occupancies, whichever is less.

7.10.2 Class II Systems.

7.10.2.1 Minimum Flow Rate.

7.10.2.1.1 For Class II systems, the minimum flow rate for the hydraulically most remote hose connection shall be 100 gpm (379 L/min).

7.10.2.1.2 Additional flow shall not be required where more than one hose connection is provided.

7.10.2.2 Hydraulic Calculation Requirements.

7.10.2.2.1 Hydraulic calculations and pipe sizes for each standpipe shall be based on providing 100 gpm (379 L/min) at the hydraulically most remote hose connection on the standpipe at the minimum residual pressure required by Section 7.8.

7.10.2.2.2 Common supply piping serving multiple standpipes shall be calculated and sized to provide 100 gpm (379 L/min).

7.10.3 Maximum Flow Rates for Individual Connections.

7.10.3.1 The maximum flow required from a 2½ in. (65 mm) hose connection shall be 250 gpm (946 L/min).

7.10.3.2 The maximum flow required from a 1½ in. (40 mm) hose connection shall be 100 gpm (379 L/min).

7.10.4 Sprinkler System Hose Demand. Sprinkler system hose demand in fully sprinklered buildings shall not be required to be added to standpipe calculations.

7.11* Drains and Test Riser.

7.11.1 A permanently installed drain riser shall be provided adjacent to each standpipe equipped with pressure-regulating devices to facilitate tests of each device. The drain shall be sized large enough to handle the full flow required from the largest pressure-regulating device but shall not be less than the following:

- (1) The size of the discharge outlet of the pressure-regulating device for devices that are greater than 2½ in. (65 mm) in size
- (2) 3 in. (80 mm) to facilitate testing of 2½ in. (65 mm) pressure-regulating devices
- (3) 2 in. (50 mm) to facilitate testing of 1½ in. (40 mm) pressure-regulating devices

7.11.1.1 The drain riser shall be equipped with connections that are of the same size as the discharge outlets of the pressure-regulating devices to be tested with internal threaded swivel fittings having NHS threads, as specified in NFPA 1963, with plugs.

7.11.1.1.1 The drain riser connections shall be located on at least every other floor.

7.11.1.2 Each drain riser shall terminate with a full-size elbow to grade or receptor that will receive the full flow from the drain riser.

7.11.1.3 Where drain risers are interconnected and run to a common discharge point, the common piping shall be sized for the combined flow.

7.11.1.4 Where local fire department hose threads do not conform to NFPA 1963, the fire department shall designate the hose threads to be used.

7.11.2 Drains. All standpipe systems shall be equipped with drain connections in accordance with this section.

7.11.2.1 A main drain shall be provided on the standpipe system in accordance with Figure 7.11.2.1.

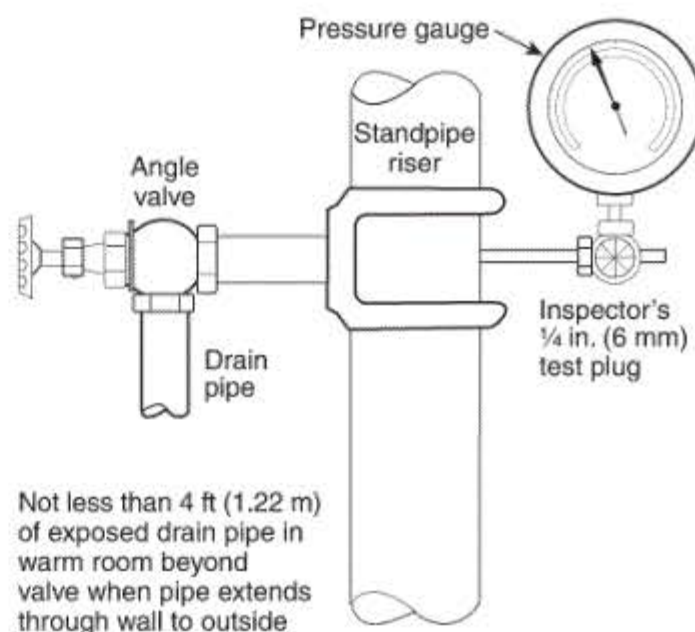

FIGURE 7.11.2.1 Drain Connection for System Riser.

7.11.2.1.1 The main drain connection shall be sized in accordance with Table 7.11.2.1.1.

N 7.11.2.1.2 The main drain connection shall discharge at a location that permits the valve to be fully opened without causing water damage.

N 7.11.2.1.3 A main drain connection shall not be required on manual wet and manual dry standpipe systems.

N 7.11.2.2 A drain connection shall be provided on the standpipe side of each standpipe isolation valve.

N 7.11.2.2.1* Where acceptable to the AHJ, the lowest hose connection shall be permitted to be used as the standpipe drain.

N 7.11.2.2.2 The drain connection shall be sized in accordance with Table 7.11.2.2.2.

Δ 7.11.2.2.3 The standpipe drain connection shall discharge at a location that permits the valve to be fully opened without causing water damage.

N 7.11.2.2.3.1 Where allowed by 7.11.2.2.1, the standpipe drain shall not be required to be piped to a drain location.

7.11.2.3 Portions of the standpipe system that are trapped such that they cannot be drained through the main drain connection or a standpipe drain connection or a standpipe drain connection shall have an auxiliary method of draining in accordance with one of the following:

- (1) An auxiliary drain in accordance with NFPA 13
- (2) An auxiliary drain connection in accordance with Table 7.11.2.2.2
- (3) A hose connection at a low point that has been approved for use with a hose to drain water out of the trapped portion of the system to a location that will not cause water damage

7.12* Fire Department Connections.

7.12.1 One or more fire department connections shall be provided for each zone of each Class I or Class III standpipe system.

7.12.1.1 The high zone fire department connection(s) shall not be required to be provided where 7.9.3 applies.

Δ Table 7.11.2.1.1 Sizing for Standpipe Riser Drains

Standpipe Riser Size	Size of Drain Connection
Up to 2 in. (50 mm)	¾ in. (20 mm) or larger
2½ in. (65 mm), 3 in. (80 mm), or 3½ in. (90 mm)	1¼ in. (32 mm) or larger
4 in. (100 mm) or larger	2 in. (50 mm) or larger

Table 7.11.2.2.2 Sizing for Standpipe Drains

Standpipe Size	Size of Drain Connection
Up to 2 in. (50 mm)	¾ in. (20 mm) or larger
2½ in. (65 mm), 3 in. (80 mm), or 3½ in. (90 mm)	1¼ in. (32 mm) or larger
4 in. (100 mm) or larger	2 in. (50 mm) or larger

7.12.2 Number of Fire Department Connections.

7.12.2.1 A minimum of one fire department connection shall be required for any standpipe system.

N 7.12.2.2* Two fire department connections shall be provided for each zone, located either on opposite corners of the buildings where fire department apparatus access is provided or, where not possible, physically separated to the greatest extent possible for the following:

- (1) High-rise buildings
- (2) Buildings or multiple attached buildings exceeding 900 ft (274.3 m) perimeter distance

N 7.12.2.3 Fire department connections shall be visible and recognizable from and located within 50 ft (15.2 m) of the street or nearest point of fire department apparatus access.

7.12.3 Fire department connection sizes shall be based on the standpipe system demand and shall include one 2½ in. (65 mm) inlet per every 250 gpm (946 L/min).

7.12.3.1 An approved large diameter hose connection of a size to accommodate the required flow shall be permitted.

7.12.3.2 The inlets required by 7.12.3 shall be permitted to be provided on multiple fire department connections.

7.12.3.3 The inlets required by 7.12.3 shall be permitted to be located in multiple locations as allowed by the AHJ.

Chapter 8 Plans and Calculations

8.1* Plans and Specifications.

8.1.1 Plans accurately showing the details and arrangement of the standpipe system shall be submitted for approval to the AHJ prior to the installation of the system.

8.1.2 Working plans shall be drawn to an indicated scale, on sheets of uniform size, and shall show those items from the following list that pertain to the design of the system:

- (1) Name of owner(s) and occupant(s)
- (2) Location, including street address
- (3) Point of compass
- (4) Name and address of installing contractor
- (5) For automatic and semiautomatic standpipe systems, the following:
 - (a) Size of city main in street and whether dead end or circulating; if dead end, direction and distance to nearest circulating main
 - (b) City main test results and system elevation relative to test hydrant
- (6) For automatic and semiautomatic standpipe systems, other sources of supply, with pressure and elevation
- (7) Approximate capacity of each dry pipe system
- (8) For automatic and semiautomatic standpipe systems, water supply capacity information, including the following:
 - (a) Location and elevation of static and residual test gauge with relation to the riser reference point
 - (b) Flow location
 - (c) Static pressure [psi (bar)]
 - (d) Residual pressure [psi (bar)]
 - (e) Flow [gpm (L/min)]
 - (f) Date

- (g) Time
- (h) Name of person who conducted the test or supplied the information
- (i) Other sources of water supply, with pressure or elevation
- (9) Pipe type and schedule of wall thickness
- (10) Nominal pipe size and cutting lengths of pipe (or center-to-center dimensions)
- (11) Type of fittings and joints and locations of all welds and bends
- (12) Type and location of hangers, sleeves, braces, and methods of securing piping
- (13) All control valves, check valves, drain pipes, and test connections
- (14) Make, type, model and size of alarm, dry pipe, or deluge valve
- (15) Type and location of alarms
- (16) Size and location of standpipes, hose connections, hand hose, nozzles, cabinets, and related equipment
- (17) Information on the hydraulic data nameplate
- (18) Hydraulic reference points shown on plan that correspond with comparable reference points on the hydraulic calculation sheets
- (19) The setting for pressure-reducing and pressure-restricting valves
- (20) The size and location of hydrant(s) and the relation to fire department connections
- (21) Size, location, and piping arrangement of fire department connections
- (22) Scale and graphical representation of the scale
- (23) Hose valve manufacturer and model
- (24) Pressure-reducing valve(s) manufacturer and model
- (25) Required pressure at hose valve outlet
- (26) Location of hose valves used in the hydraulic calculations
- (27) Standpipe system demand (flow and pressure) at the following locations:
 - (a) Fire department connection (FDC) inlet
 - (b) Fire pump discharge flange
 - (c) Water supply tank discharge
 - (d) Water supply source if different from (a) through (c)

8.1.3 The drawings shall show the location, arrangement, water supply, equipment, and all other details necessary to establish compliance with this standard.

8.1.4* The plans shall include specifications covering the character of materials used and shall describe all system components.

8.1.5 The plans shall include an elevation diagram, and the vertical elevation of each floor shall be indicated.

8.2 Hydraulic Calculations.

8.2.1 Standpipe system piping shall be sized by hydraulic calculations.

8.2.2 A complete set of calculations shall be submitted with the plans.

8.2.3* Hydraulic calculations shall be prepared on form sheets that include a summary sheet, detailed worksheets, and a graph sheet. [13:27.4.1]

8.2.4 Summary Sheet. The summary sheet shall contain the following information, where applicable:

- (1) Date
- (2) Location
- (3) Name of owner and occupant
- (4) Building number or other identification
- (5) Description of hazard
- (6) Name and address of contractor or designer
- (7) Name of approving agency
- (8) System design requirements, as follows:
 - (a) Number of standpipes flowing
 - (b) Minimum rate of water application gpm (L/min)
- (9) Total water requirements as calculated, including individual standpipe and partial sprinkler demand

8.2.5 Detailed Worksheets. Detailed worksheets or computer printout sheets shall contain the following information:

- (1) Sheet number
- (2) Hose connection description and discharge constant (K)
- (3) Hydraulic reference points
- (4) Flow in gpm (L/min)
- (5) Pipe size
- (6) Pipe lengths, center-to-center of fittings
- (7) Equivalent pipe lengths for fittings and devices
- (8) Friction loss in psi/ft (bar/m) of pipe
- (9) Total friction loss between reference points
- (10) Devices per 8.3.1.5
- (11) Elevation head in psi (bar) between reference points
- (12) Required pressure in psi (bar) at each reference point
- (13) Velocity pressure and normal pressure if included in calculations
- (14) Notes to indicate starting points or reference to other sheets or to clarify data shown

8.2.6 Graph Sheet. A graphic representation of the complete hydraulic calculation shall be plotted on semiexponential graph paper ($Q^{1.85}$) and shall include the following:

- (1) Water supply curve
- (2) Standpipe system demand
- (3) Hose demand (where applicable)
- (4) Partial sprinkler demand where applicable (*see 7.10.1.3.2*)

8.3 Hydraulic Calculation Procedures.

8.3.1 General.

8.3.1.1 For all systems, the hydraulic calculations shall be the most demanding based on the criteria of Chapter 7.

Δ 8.3.1.2 Calculations shall begin at each hose connection and shall include the friction loss for the hose valve and any connecting piping from the hose valve to the standpipe.

8.3.1.3 Table 8.3.1.3 shall be used to determine the equivalent length of pipe for fittings and devices unless the manufacturer's published data indicate that other factors are more accurate.

8.3.1.4 For saddle-type fittings having friction loss greater than that shown in Table 8.3.1.3, the increased friction loss shall be included in the hydraulic calculations.

Table 8.3.1.3 Equivalent Pipe Length Chart

Fittings and Valves	Fittings and Valves Expressed in Equivalent Feet of Pipe													
	¼ in.	1 in.	1¼ in.	1½ in.	2 in.	2½ in.	3 in.	3½ in.	4 in.	5 in.	6 in.	8 in.	10 in.	12 in.
45 degree elbow	1	1	1	2	2	3	3	3	4	5	7	9	11	13
90 degree standard elbow	2	2	3	4	5	6	7	8	10	12	14	18	22	27
90 degree long-turn elbow	1	2	2	2	3	4	5	5	6	8	9	13	16	18
Tee or cross (flow turned 90 degrees)	3	5	6	8	10	12	15	17	20	25	30	35	50	60
Butterfly valve	—	—	—	—	6	7	10	—	12	9	10	12	19	21
Gate valve	—	—	—	—	1	1	1	1	2	2	3	4	5	6
Swing check*	—	5	7	9	11	14	16	19	22	27	32	45	55	65
Globe (straight) hose valve	—	—	—	46	—	70	—	—	—	—	—	—	—	—
Angle or hose valve	—	—	—	20	—	31	—	—	—	—	—	—	—	—

For SI units, 1 in. = 25.4 mm.

*Due to the variations in design of swing check valves, the pipe equivalents indicated in this table are considered to be average.

Table 8.3.2.2 Adjustment Factors for C Values

Multiplying Factor	C Value
0.713	100
1.16	130
1.33	140
1.51	150

8.3.1.5 Valves. Specific friction loss values or equivalent pipe lengths for alarm valves, dry pipe valves, deluge valves, strainers, and other devices shall be made available to the AHJ. [13:27.2.3.3]

8.3.1.6 Differing Values. Specific friction loss values or equivalent pipe lengths for listed fittings not in Table 4.3.1 shall be used in hydraulic calculations where these losses or equivalent pipe lengths are different from those shown in Table 8.3.1.3. [13:27.2.3.5]

8.3.2 Adjustments.

8.3.2.1 Table 8.3.1.3 shall be used only where the Hazen-Williams C factor is 120.

8.3.2.2 For other values of C, the values in Table 8.3.1.3 shall be multiplied by the factors indicated in Table 8.3.2.2.

8.3.2.3 Table 8.3.2.3 indicates typical C factors that shall be used for commonly used piping materials.

8.3.2.4 The AHJ shall be permitted to require other C values.

8.3.2.5 For internal pipe diameters different from Schedule 40 steel pipe [Schedule 30 for pipe diameters 8 in. (200 mm) and larger], the equivalent length shown in Table 8.3.1.3 shall be multiplied by a factor derived from the following equation:

[8.3.2.5]

$$\left(\frac{\text{Actual inside diameter}}{\text{Schedule 40 steel pipe inside diameter}} \right)^{4.87} = \text{Factor}$$

Table 8.3.2.3 Hazen-Williams C Values

Pipe or Tube	C Value
Unlined cast or ductile-iron	100
Black steel (dry)	100
Black steel (wet)	120
Galvanized (wet)	120
Galvanized (dry)	100
Plastic (listed all)	150
Cement-lined cast or ductile-iron	140
Copper tube or stainless steel	150

8.3.2.5.1 The factor thus obtained shall be further modified as required by Table 8.3.2.2. This table shall apply to other types of pipe listed in Table 8.3.2.3 only where modified by factors from 8.3.2.3 and 8.3.2.5.

8.3.3 Formulas.

8.3.3.1 Friction Loss Formula.

8.3.3.1.1 Pipe friction losses shall be determined on the basis of the Hazen-Williams formula, as follows:

[8.3.3.1.1]

$$p = \frac{4.52Q^{1.85}}{C^{1.85}d^{4.87}}$$

where:

p = frictional resistance (psi/ft of pipe)

Q = flow (gpm)

C = friction loss coefficient

d = actual internal diameter of pipe (in.)

[13:27.2.2.1.1]

8.3.3.1.2 For SI units, the following equation shall be used:

$$p_m = 6.05 \left(\frac{Q_m^{1.85}}{C^{1.85} d_m^{4.87}} \right) 10^5 \quad [8.3.3.1.2]$$

where:

p_m = frictional resistance (bar/m of pipe)

Q_m = flow (L/min)

C = friction loss coefficient

d_m = actual internal diameter (mm)

[13:27.2.2.1.2]

Chapter 9 Water Supply

9.1* Required Water Supply.

9.1.1 Automatic and semiautomatic standpipe systems shall be attached to an approved water supply capable of supplying the system demand.

9.1.2 Manual standpipe systems shall have an approved water supply accessible to a fire department pumper.

9.1.3 A single automatic or semiautomatic water supply shall be permitted where it is capable of supplying the system demand for the required duration.

9.1.4 Where fire department pumpers cannot supply the required system demand through a fire department connection, an auxiliary water supply consisting of high-level water storage with additional pumping equipment or other means acceptable to the AHJ shall be provided.

9.1.4.1 The auxiliary water supply shall meet the 30-minute minimum water supply requirements of Section 9.2.

9.1.5 Water supplies from the following sources shall be permitted:

- (1) A public waterworks system where pressure and flow rate are adequate
- (2) Automatic fire pumps connected to an approved water source in accordance with NFPA 20
- (3) Manually controlled fire pumps in combination with pressure tanks
- (4) Pressure tanks installed in accordance with NFPA 22
- (5) Manually controlled fire pumps operated by remote control devices at each hose station, supervised in accordance with NFPA 72, at each hose station
- (6) Gravity tanks installed in accordance with NFPA 22

9.2 **Minimum Supply for Class I, Class II, and Class III Systems.** The minimum water supply shall be capable of providing the system demand established by Sections 7.8 and 7.10 for at least 30 minutes.

Chapter 10 Water Supply Testing

10.1* **Water Supply Evaluation.** The water flow rate and pressure of a public water supply shall be determined from water-flow test data or other approved method.

10.1.1 Daily and seasonal flow and pressure fluctuation data shall be provided by the water purveyor, and the fire protection design must account for both high and low variations.

10.1.1.1 Where these data are not available, design shall be based on the available water flow data.

10.2* **Procedure.** Where a waterflow test is used for the purposes of system design, the test shall be conducted no more than 12 months prior to working plan submittal unless otherwise approved by the AHJ. [13:4.6.1.1]

Chapter 11 System Acceptance

11.1* General.

11.1.1 All new systems shall be tested prior to the occupancy of the building.

11.1.2 Existing standpipe systems that are to be utilized as standpipes for a combination system in the retrofit of a new sprinkler system shall be tested in accordance with Section 11.4.

11.1.3 The installing contractor shall complete and sign the appropriate contractor's material and test certificate(s) as shown in Figure 11.1.3(a) and Figure 11.1.3(b).

11.2 Flushing of Piping.

11.2.1 Underground piping supplying the system shall be flushed in accordance with NFPA 24.

11.2.2 Piping between the fire department connection and the check valve in the inlet pipe shall be flushed with a sufficient volume of water in order to remove any construction debris and trash accumulated in the piping prior to the completion of the system and prior to the installation of the fire department connection.

11.3 Hose Threads.

11.3.1 All hose connection and fire department connection threads shall be tested to verify their compatibility with threads used by the local fire department.

11.3.1.1 The test shall consist of threading coupling samples, caps, or plugs onto the installed devices.

11.4 Hydrostatic Tests.

11.4.1* **General.** All new systems, including yard piping and fire department connection piping, shall be tested hydrostatically at not less than 200 psi (13.8 bar) or 50 psi (3.5 bar) in excess of the system working pressure, whichever is greater for 2 hours.

11.4.2 The hydrostatic test pressure shall be measured at the low elevation point of the individual system or zone being tested.

11.4.3 The standpipe system piping shall show no leakage other than as permitted by 11.4.4.

11.4.4 Underground pipe shall be tested in accordance with NFPA 24.

CONTRACTOR'S MATERIAL AND TEST CERTIFICATE FOR ABOVEGROUND PIPING

Standpipe System NFPA 14

PROCEDURE
 Upon completion of work, inspection and tests shall be made by the contractor's representative and witnessed by an owner's representative. All defects shall be corrected and the system left in service before the contractor's personnel finally leave the job.

A certificate shall be filled out and signed by both representatives. Copies shall be prepared for approving authorities, owners, and contractor. It is understood that the owner's representative's signature in no way prejudices any claim against the contractor for faulty material, poor workmanship, or failure to comply with the approving authority's requirements or local ordinances.

Property name	Date
Property address	
Plans	Accepted by approving authorities (names) _____
	Address _____
	Installation conforms to accepted plans? <input type="checkbox"/> Yes <input type="checkbox"/> No
	Equipment used is approved or listed? <input type="checkbox"/> Yes <input type="checkbox"/> No If no, explain deviations. _____
Type of System	<input type="checkbox"/> Automatic dry <input type="checkbox"/> Automatic wet <input type="checkbox"/> Semiautomatic dry <input type="checkbox"/> Manual dry <input type="checkbox"/> Manual wet <input type="checkbox"/> Combination standpipe/sprinkler If other, explain. _____
	Water Supply Data Used for Design and As Shown on Plans Fire pump data Manufacturer _____ Model _____ Type: <input type="checkbox"/> Electric <input type="checkbox"/> Diesel <input type="checkbox"/> Other (explain) _____ Rated, gpm _____ Rated, psi _____ Shutoff, psi _____
Water Supply Source Capacity, Gallons	<input type="checkbox"/> Public waterworks system _____ (gal) <input type="checkbox"/> Storage tank _____ (gal) <input type="checkbox"/> Gravity tank _____ (gal) <input type="checkbox"/> Open reservoir _____ (gal) <input type="checkbox"/> Other (explain) _____
If Public Waterworks System:	Static, psi _____ Residual, psi _____ Flow, gpm _____
Have Copies of the Following Been Provided to the Owner or Owner's Representative?	<input type="checkbox"/> System components instructions <input type="checkbox"/> Care and maintenance of system <input type="checkbox"/> NFPA 25 <input type="checkbox"/> Copy of accepted plans <input type="checkbox"/> Hydraulic data/calculations
Supplies Building(s)	Main waterflow shutoff location _____ Number of standpipe risers _____ Do all standpipe risers have base of riser shutoff valves? <input type="checkbox"/> Yes <input type="checkbox"/> No
Valve Supervision	<input type="checkbox"/> Locked open <input type="checkbox"/> Sealed and tagged <input type="checkbox"/> Tamperproof switch <input type="checkbox"/> Other If other, explain. _____
Pipe and Fittings	Type of pipe _____ Type of fittings _____
Hose Threads	Hose threads have been verified for compliance with local fire department <input type="checkbox"/> Yes <input type="checkbox"/> No
Backflow Preventor	<input type="checkbox"/> Double check assembly <input type="checkbox"/> Reduced-pressure device Size _____ Make and model _____

© 2018 National Fire Protection Association NFPA 14 (p. 1 of 3)

▲ FIGURE 11.1.3(a) Sample Contractor's Material and Test Certificate for Aboveground Piping.

CONTROL VALVE DEVICE						
Type	Size	Make	Model			

Time to trip through remote hose valve _____ Min _____ Sec Water pressure _____ Air pressure _____
 Time water reached remote hose valve outlet _____ Min _____ Sec Trip point air pressure _____ psi
 Alarm operated properly? Yes No If no, explain. _____

Time water reached remote hose valve outlet _____ Min _____ Sec
 Hydraulic activation Yes
 Electric activation Yes
 Pneumatic activation Yes
 Make and model of activation device _____
 Each activation device tested? Yes No If no, explain. _____

Each activation device operated properly? Yes No If no, explain. _____

PRESSURE-REGULATING DEVICE						
Location & Floor	Model	Nonflowing (psi)		Flowing (psi)		gpm
		Inlet	Outlet	Inlet	Outlet	

All hose valves on system operated properly? Yes No If no, explain. _____

© 2018 National Fire Protection Association NFPA 14 (p. 2 of 3)

Δ FIGURE 11.1.3(a) Continued

Test Description	<p><i>Hydrostatic:</i> Hydrostatic tests shall be made at not less than 200 psi (13.6 bar) for 2 hours or 50 psi (3.4 bar) above static pressure in excess of 150 psi (10.2 bar) for 2 hours. Differential dry pipe valve clappers shall be left open during test to prevent damage. All aboveground piping leakage shall be stopped.</p> <p><i>Pneumatic:</i> Establish 40 psi (2.7 bar) air pressure and measure drop, which shall not exceed 1½ psi (0.1 bar) in 24 hours. Test pressure tanks at normal water level and air pressure and measure air pressure drop, which shall not exceed 1½ psi (0.1 bar) in 24 hours.</p>		
Tests	Hydrostatic Test — Pressure at top of standpipe(s) STP# _____ Pressure _____ (psi) (_____ bar) STP# _____ Pressure _____ (psi) (_____ bar) STP# _____ Pressure _____ (psi) (_____ bar) STP# _____ Pressure _____ (psi) (_____ bar) STP# _____ Pressure _____ (psi) (_____ bar) STP# _____ Pressure _____ (psi) (_____ bar)		
	All piping hydrostatically tested at _____ psi (_____ bar) for _____ hrs Dry piping pneumatically tested? <input type="checkbox"/> Yes <input type="checkbox"/> No Equipment operates properly? <input type="checkbox"/> Yes <input type="checkbox"/> No		If no, state reason.
	Do you certify as the standpipe contractor that additives and corrosive chemicals, sodium silicate, or derivatives of sodium silicate, brine, or other corrosive chemicals were not used for testing systems or stopping leaks? <input type="checkbox"/> Yes <input type="checkbox"/> No		
	Drain test	Reading of gauge located near water supply test connection _____ psi (_____ bar)	Residual pressure with valve in test connection open wide _____ psi (_____ bar)
	Underground mains and lead-in connections to system risers flushed before connection made to standpipe piping. Verified by copy of the underground test form? <input type="checkbox"/> Yes <input type="checkbox"/> No <input type="checkbox"/> Other (explain) _____ Flushed by installer of underground standpipe piping? <input type="checkbox"/> Yes <input type="checkbox"/> No _____		
Flow Test	Flow water from the hydraulically most remote standpipe outlet(s). Record: Static pressure: _____ psi (_____ bar) Residual pressure: _____ psi (_____ bar) Nozzle diameter: _____ in. (_____ cm) Pitot pressure: _____ psi (_____ bar) Total flow: _____ gpm (_____ L/min)		
Blank Testing	Number used _____	Locations _____	Number removed _____
Welding	Welded piping <input type="checkbox"/> Yes <input type="checkbox"/> No		
	If yes ...		
	Do you certify as the standpipe contractor that welding procedures comply with the requirements of at least AWS D10.9, Level AR-3?		<input type="checkbox"/> Yes <input type="checkbox"/> No
	Do you certify that the welding was performed by welders qualified in compliance with the requirements of at least AWS D10.9, Level AR-3?		<input type="checkbox"/> Yes <input type="checkbox"/> No
Do you certify that welding was carried out in compliance with a documented quality control procedure to ensure that all discs are retrieved, that openings in piping are smooth, that slag and other welding residue are removed, and that the internal diameters of piping are not penetrated?		<input type="checkbox"/> Yes <input type="checkbox"/> No	
Cutouts (Discs)	Do you certify that you have a control feature to ensure that all cutouts (discs) are retrieved?		<input type="checkbox"/> Yes <input type="checkbox"/> No
Hydraulic Data Nameplate	Nameplate provided? <input type="checkbox"/> Yes <input type="checkbox"/> No <input type="checkbox"/> If no, explain. _____		
Remarks	Date left in service with all control valves open: _____		
Name of Sprinkler/Standpipe Contractor	Name of contractor _____ Address _____ State license number (if applicable) _____		
System Operating Test Witnessed by	Property owner _____ Title _____ Date _____	Sprinkler/standpipe contractor _____ Title _____ Date _____	Approving authorities _____ Title _____ Date _____
Additional Explanation and Notes	_____		

▲ FIGURE 11.1.3(a) Continued

Contractor's Material and Test Certificate for Underground Piping			
<p>PROCEDURE Upon completion of work, inspection and tests shall be made by the contractor's representative and witnessed by an owner's representative. All defects shall be corrected and system left in service before contractor's personnel finally leave the job. A certificate shall be filled out and signed by both representatives. Copies shall be prepared for approving authorities, owners, and contractor. It is understood the owner's representative's signature in no way prejudices any claim against contractor for faulty material, poor workmanship, or failure to comply with approving authority's requirements or local ordinances.</p>			
Property name	Date		
Property address			
Plans	Accepted by approving authorities (names)		
	Address		
	Installation conforms to accepted plans <input type="checkbox"/> Yes <input type="checkbox"/> No Equipment used is approved <input type="checkbox"/> Yes <input type="checkbox"/> No If no, state deviations		
Instructions	Has person in charge of fire equipment been instructed as to location of control valves and care and maintenance of this new equipment? If no, explain <input type="checkbox"/> Yes <input type="checkbox"/> No		
	Have copies of appropriate instructions and care and maintenance charts been provided to the owner or owner's representative? If no, explain <input type="checkbox"/> Yes <input type="checkbox"/> No		
Location	Supplies buildings		
Underground pipes and joints	<table style="width: 100%; border: none;"> <tr> <td style="width: 50%; border: none;">Pipe types and class</td> <td style="width: 50%; border: none;">Type joint</td> </tr> </table>	Pipe types and class	Type joint
	Pipe types and class	Type joint	
	Pipe conforms to _____ standard <input type="checkbox"/> Yes <input type="checkbox"/> No Fittings conform to _____ standard <input type="checkbox"/> Yes <input type="checkbox"/> No If no, explain		
Joints needing anchorage clamped, strapped, or blocked in accordance with _____ standard <input type="checkbox"/> Yes <input type="checkbox"/> No If no, explain			
Test description	<p>Flushing: Flow the required rate until water is verified to be clear of debris at outlets such as hydrants and blow-offs. Flush at one of the flow rates as specified in 10.10.2.1.3 of NFPA 24. Hydrostatic: All piping and attached appurtenances subjected to system working pressure shall be hydrostatically tested at 200 psi (13.8 bar) or 50 psi (3.4 bar) in excess of the system working pressure, whichever is greater, and shall maintain that pressure ±5 psi (0.34 bar) for 2 hours. Hydrostatic Testing Allowance: Where additional water is added to the system to maintain the test pressures required by 10.10.2.2.1 of NFPA 24, the amount of water shall be measured and shall not exceed the limits of the following equation (for metric equation, see 10.10.2.2.6 of NFPA 24):</p> $L = \frac{SD\sqrt{P}}{148,000}$ <p style="font-size: small;"> <i>L</i> = testing allowance (makeup water), in gallons per hour (lpm) <i>S</i> = length of pipe tested, in feet (m) <i>D</i> = nominal diameter of the pipe, in inches (mm) <i>P</i> = average test pressure during the hydrostatic test, in pounds per square inch (gauge) (bar) </p>		
Flushing tests	New underground piping flushed according to _____ standard by (company) <input type="checkbox"/> Yes <input type="checkbox"/> No If no, explain		
	<table style="width: 100%; border: none;"> <tr> <td style="width: 50%; border: none;"> How flushing flow was obtained <input type="checkbox"/> Public water <input type="checkbox"/> Tank or reservoir <input type="checkbox"/> Fire pump </td> <td style="width: 50%; border: none;"> Through what type opening <input type="checkbox"/> Hydrant butt <input type="checkbox"/> Open pipe </td> </tr> </table>	How flushing flow was obtained <input type="checkbox"/> Public water <input type="checkbox"/> Tank or reservoir <input type="checkbox"/> Fire pump	Through what type opening <input type="checkbox"/> Hydrant butt <input type="checkbox"/> Open pipe
	How flushing flow was obtained <input type="checkbox"/> Public water <input type="checkbox"/> Tank or reservoir <input type="checkbox"/> Fire pump	Through what type opening <input type="checkbox"/> Hydrant butt <input type="checkbox"/> Open pipe	
	Lead-ins flushed according to _____ standard by (company) <input type="checkbox"/> Yes <input type="checkbox"/> No If no, explain		
<table style="width: 100%; border: none;"> <tr> <td style="width: 50%; border: none;"> How flushing flow was obtained <input type="checkbox"/> Public water <input type="checkbox"/> Tank or reservoir <input type="checkbox"/> Fire pump </td> <td style="width: 50%; border: none;"> Through what type opening <input type="checkbox"/> Y connection to flange and spigot <input type="checkbox"/> Open pipe </td> </tr> </table>	How flushing flow was obtained <input type="checkbox"/> Public water <input type="checkbox"/> Tank or reservoir <input type="checkbox"/> Fire pump	Through what type opening <input type="checkbox"/> Y connection to flange and spigot <input type="checkbox"/> Open pipe	
How flushing flow was obtained <input type="checkbox"/> Public water <input type="checkbox"/> Tank or reservoir <input type="checkbox"/> Fire pump	Through what type opening <input type="checkbox"/> Y connection to flange and spigot <input type="checkbox"/> Open pipe		
© 2018 National Fire Protection Association NFPA 24 (p. 1 of 2)			

▲ FIGURE 11.1.3(b) Sample of Contractor's Material and Test Certificate for Underground Piping. [24:Figure 10.10.1]

Hydrostatic test	All new underground piping hydrostatically tested at _____ psi (bar) for _____ hours		Joints covered <input type="checkbox"/> Yes <input type="checkbox"/> No	
	Total amount of leakage measured _____ gallons (liters) _____ hours			
Leakage test	Allowable leakage _____ gallons (liters) _____ hours			
	Forward flow test performed in accordance with 10.10.2.5.2 of NFPA 24: <input type="checkbox"/> Yes <input type="checkbox"/> No			
Hydrants	Number installed	Type and make	All operate satisfactorily <input type="checkbox"/> Yes <input type="checkbox"/> No	
	Water control valves left wide open If no, state reason		<input type="checkbox"/> Yes <input type="checkbox"/> No	
Control valves	Hose threads of fire department connections and hydrants interchangeable with those of fire department answering alarm		<input type="checkbox"/> Yes <input type="checkbox"/> No	
	Date left in service			
Remarks				
Signatures	Name of installing contractor			
	Tests witnessed by			
	For property owner (signed)	Title	Date	
	For installing contractor (signed)	Title	Date	
Additional explanation and notes				
<div style="display: flex; justify-content: space-between;"> © 2018 National Fire Protection Association NFPA 24 (p. 2 of 2) </div>				

▲ FIGURE 11.1.3(b) Continued

11.4.5 Where cold weather prevents testing with water, an interim air test shall be permitted to be conducted prior to the standard hydrostatic test.

11.4.5.1 An air pressure leakage test at 40 psi (2.8 bar) shall be conducted for 24 hours.

11.4.5.2 Any leakage that results in a loss of pressure in excess of 1½ psi (0.1 bar) during a continuous 24-hour period shall be corrected.

11.4.6 Fire Department Connection. Piping between the fire department connection and the check valve in the inlet pipe shall be tested hydrostatically in the same manner as the balance of the system.

11.4.7 Existing Systems.

11.4.7.1 Where an existing standpipe system, including yard piping and fire department connection, is modified, the new piping shall be independently tested in accordance with 11.4.1.

11.4.7.2 Modifications that cannot be isolated, such as new valves or the point of connection for new piping, shall not require testing in excess of system static pressure.

11.4.8 Protection from Freezing. During testing, care shall be taken to ensure that no portion of the piping is subject to freezing during cold weather.

11.4.9 Gauges. During the hydrostatic test, the pressure gauge at the top of each standpipe shall be observed and the pressure recorded.

11.4.10 The test pressure shall be read from a gauge located at the low elevation point of the system or portion being tested. The pressures in piping at higher elevations shall be permitted to be less than the pressures required by 11.4.1 or 11.4.5.1 when accounting for elevation losses. Systems or portions of systems that can be isolated shall be permitted to be tested separately.

11.4.11 Water Additives. Additives, corrosive chemicals such as sodium silicate or derivatives of sodium silicate, brine, or other chemicals shall not be used while hydrostatically testing systems or for stopping leaks.

11.5 Flow Tests.

11.5.1* The standpipe system shall be tested to verify system demand.

11.5.1.1 The test required by 11.5.1 shall be permitted to be waived where acceptable to the AHJ.

11.5.1.2 This test shall be conducted by flowing water simultaneously from the hose connection(s) indicated in the approved hydraulic calculations of each standpipe as required by Sections 7.8 and 7.10.

11.5.1.2.1 For each additional standpipe, the required flow shall be permitted to be taken from any hose connection on that standpipe.

11.5.2* For a manual standpipe, a fire department pumper, portable pump of a capacity to provide the required flow and pressure, or other approved means shall be used to verify the system design by pumping into the fire department connection.

11.5.2.1 Where allowed by the AHJ, the test required by 11.5.2 shall be permitted to be waived.

11.5.3 Backflow Prevention Assemblies.

11.5.3.1 The backflow prevention assembly shall be forward flow tested to ensure proper operation. [13:28.2.5.1]

11.5.3.2 The minimum flow rate shall be the system demand.

11.5.4 The filling arrangement for suction tanks shall be verified by shutting down all supplies to the tank, draining the tank to below the designated low water level, and then opening the supply valve to ensure operation of its automatic features.

11.5.5 Pressure-Regulating Devices.

11.5.5.1* Each pressure-regulating device shall be tested to verify that the installation is correct, that the device is operating, and that the inlet and outlet pressures and flow at the device are in accordance with the design.

11.5.5.1.1 Where pressure-reducing valves are arranged in series, the downstream pressure-reducing valve shall be tested at both the discharge pressure from the upstream pressure-reducing valve and with the upstream pressure-reducing valve bypass open.

11.5.5.2 Static and residual inlet pressure and static and residual outlet pressure and flow shall be recorded on the contractor's test certificate.

11.5.6 Main Drain Flow Test.

11.5.6.1 The main drain valve shall be opened and shall remain open until the system pressure stabilizes.

11.5.6.2 The static and residual pressure shall be recorded on the contractor's test certificate.

11.5.6.3 Main drain flow tests are not required for manual systems that do not have a permanently attached water supply.

11.5.7 Testing of Automatic Dry and Semiautomatic Systems.

11.5.7.1 Automatic dry and semiautomatic systems shall be tested by initiating a flow of water from the hydraulically most remote hose connection.

11.5.7.2 The system shall deliver a minimum of 250 gpm (946 L/min) at the hose connection within 3 minutes of opening the hose valve if the system capacity exceeds 750 gal (2480 L).

11.5.7.3 Each remote control activation device for operating a semiautomatic system shall be tested in accordance with the manufacturer's specifications and instructions.

11.5.7.4 In addition to the standard hydrostatic test, an air pressure leakage test at 40 psi (2.7 bar) shall be conducted for 24 hours. Any leakage that results in a loss of pressure in excess of 1½ psi (0.1 bar) for the 24 hours shall be corrected. [13:28.2.2.1]

11.5.7.5 These tests shall be conducted in addition to all the tests required for automatic and manual systems.

11.5.8 Where pumps are part of the water supply for a standpipe system, testing shall be conducted while the pumps are operating.

11.6 Manual Valve Test.

11.6.1 Each valve intended to be manually opened or closed shall be operated by turning the handwheel crank or wrench for its full range and returning it to its normal position.

11.6.2 Hose valve caps shall be tightened sufficiently to avoid leaking during the test and removed after the test to drain water and relieve pressure.

N 11.7 Automated Inspection and Testing Devices and Equipment.

N 11.7.1 Automated inspection and testing devices and equipment installed on the standpipe system shall be tested to ensure the desired result of the automated inspection or test is realized.

N 11.7.1.1 Automated inspection devices and equipment shall prove to be as effective as a visual examination.

N 11.7.1.2 Automated testing devices and equipment shall produce the same action required by this standard to test a device.

N 11.7.1.2.1 The testing shall discharge water where required by this standard and NFPA 25.

N 11.7.2 Failure of automated inspection and testing devices and equipment shall not impair the operation of the standpipe system unless indicated by an audible and visual trouble signal in accordance with NFPA 72.

N 11.7.3 Failure of a system or component to pass automated inspection and testing devices and equipment shall result in an audible and visual trouble signal in accordance with NFPA 72.

N 11.7.4 Failure of automated inspection and testing devices and equipment shall result in an audible and visual trouble signal in accordance with NFPA 72.

11.8 Alarm and Supervision Tests. Each alarm and supervisory device provided shall be tested in accordance with NFPA 72.

11.9* Record Drawings, Test Reports, and Manuals.

11.9.1 One set of record drawings shall be provided to the building owner.

11.9.2 One copy of the completed test report shall be provided to the building owner.

11.9.3 Acceptance test reports shall be maintained by the system owner for the life of the system.

11.9.4 One set of instruction manuals for all major components of the standpipe system shall be provided to the building owner. The manual shall contain the following:

- (1) An explanation of the operation of the component
- (2) Manufacturer's instructions for routine maintenance
- (3) Manufacturer's instructions concerning repairs
- (4) Manufacturer's parts list and identification for serviceable components
- (5) A copy of the current edition of NFPA 25

11.10 Signs. The installation of signs required by this standard shall be verified.

Chapter 12 Buildings Under Construction

12.1 General. In all new buildings in which standpipes are required or where standpipes exist in buildings being altered or demolished, such standpipes shall be maintained in conformity with the progress of building construction in such a manner that they are always ready for use. [241:7.6]

12.2 Fire Department Connections. The standpipes shall be provided with conspicuously marked and readily accessible fire department connections on the outside of the building at the street and shall have at least one standard hose outlet at each floor. [241:8.7.4.2.1]

12.3 Other System Features. The pipe sizes, hose valves, hose, water supply, and other details for new construction shall be in accordance with this standard. [241:8.7.4.2.2]

12.4 Support of Piping. The standpipes shall be securely supported and restrained at each alternate floor. [241:8.7.4.2.3]

12.5* Hose Connections.

12.5.1 At least one approved hose valve for attaching fire department hose shall be provided at each intermediate landing or floor level in the exit stairway, as determined by the AHJ. [241:8.7.4.2.4]

12.5.2 Hose valves shall be kept closed at all times and guarded against mechanical injury. [241:8.7.4.2.5]

12.6 Extension of System Piping. The standpipes shall be extended up with each floor and shall be securely capped at the top. [241:8.7.4.2.8]

12.6.1 Top hose outlets shall be not more than one floor below the highest forms, staging, and similar combustibles at all times. [241:8.7.4.2.9]

12.7 Temporary Installations.

12.7.1 Temporary standpipes shall remain in service until the permanent standpipe installation is complete. [241:8.7.4.2.10]

12.7.2 Where temporary standpipes normally contain water, the piping shall be protected against freezing.

12.8 Timing of Water Supply Installation.

12.8.1 Where construction reaches a height at which public waterworks system pressure can no longer provide the required flow and pressure, temporary or permanent fire pumps shall be installed to provide protection to the uppermost level or to the height required by the AHJ.

12.8.2 Where local fire department pumping apparatus is permitted by the AHJ for the standpipe pressure required, temporary or permanent fire pumps shall not be required.

12.9 Protection of Hose Connections and Fire Department Connections.

12.9.1 Threaded caps and plugs shall be installed on fire department connections and hose connections.

12.9.2 Fire department connections and hose connections shall be protected against physical damage.

Chapter 13 Maritime Standpipes and Hose Systems

13.1 Application.

N 13.1.1 This chapter shall apply to the installation of standpipes and hose systems installed at or on marinas, boatyards, marine terminals, piers, docks, and wharves.

N 13.1.2 This chapter shall apply where standpipes and hose systems for the environments described in 13.1.1 are required by another code or standard.

N 13.1.3 The requirements of Chapter 5 through Chapter 12 shall not apply unless otherwise noted.

13.2 Components and Hardware.

13.2.1 Pipe and Tube.

N 13.2.1.1 Pipe and tube used in maritime standpipe systems shall be in accordance with Table 13.2.1.1, Section 4.2, 13.2.1.2, 13.2.1.3, or 13.2.1.4.

N 13.2.1.2 Where approved by the AHJ, listed underground pipe shall be permitted to be installed underneath piers.

N 13.2.1.3* Where approved by the AHJ, materials outside of those in Section 4.2 are permitted to be used.

N 13.2.1.4* Where approved by the AHJ, listed HDPE pipe shall be permitted to be installed on floating piers in accordance with this chapter.

13.2.2 Fittings.

N 13.2.2.1 Fittings used in maritime standpipe systems shall be in accordance with Table 13.2.2.1, Section 4.3, or 13.2.2.2.

N 13.2.2.2 When pipe and tube is used in accordance with 13.2.1.3, fittings shall be a suitable type according to the manufacturer and approved by the AHJ.

13.2.3 Joining of Pipe and Fittings.

N 13.2.3.1 Joining of pipe and fittings shall be in accordance with Section 4.4 or 13.2.3.2.

N 13.2.3.2 When pipe and tube is used in accordance with 13.2.1.3, joining of pipe and fittings shall be in accordance with the manufacturer's specifications and approved by the AHJ.

N 13.2.3.3 HDPE pipe and fittings shall be joined to ASTM F2620, *Standard Practice for Heat Fusion Joining of Polyethylene Pipe and Fittings*, or other methods in accordance with their listing.

13.2.3.4 Restraint.

N 13.2.3.4.1 Where underground piping is installed underneath piers, all joints shall be restrained using one of the following methods:

- (1) Locking mechanical or push-on joints
- (2) Mechanical joints utilizing setscrew retainer glands
- (3) Bolted flange joints
- (4) Pipe clamps and tie rods
- (5) Other approved methods or devices

N 13.2.3.4.2 The following connection methods shall not require additional restraint provided that such joints can pass the hydrostatic test without shifting of piping:

- (1) Threaded connections
- (2) Grooved connections
- (3) Welded connections
- (4) Heat-fused connections
- (5) Chemical or solvent cemented connections

Table 13.2.1.1 Pipe or Tube Materials and Dimensions

Materials and Dimensions (Specifications)	Standard
Ferrous piping	
<i>Cement-Mortar Lining for Ductile-Iron Pipe and Fittings</i>	AWWA C104/A21.4
<i>Polyethylene Encasement for Ductile-Iron Pipe Systems</i>	AWWA C105/A21.5
<i>Rubber-Gasket Joints for Ductile-Iron Pressure Pipe and Fittings</i>	AWWA C111/A21.11
<i>Thickness Design of Ductile-Iron Pipe</i>	AWWA C150
<i>Installation of Ductile-Iron Water Mains and Their Appurtenances</i>	AWWA C600
Plastic	
<i>Standard Specification for Chlorinated Poly(Vinyl Chloride) (CPVC) Plastic Pipe (SDR-PR)</i>	ASTM F442/F442M
<i>Polyvinyl Chloride (PVC) Pressure Pipe and Fabricated Fittings, 4 In. Through 60 In. (100 mm Through 1,500 mm)</i>	AWWA C900
<i>Polyvinyl Chloride (PVC) Pressure Pipe and Fabricated Fittings, 14 in. Through 48 in. (350 mm through 1,200 mm), for Water Transmission and Distribution</i>	AWWA C905
<i>Polyethylene (PE) Pressure Pipe and Fittings, 4 In. Through 65 In. (100 mm Through 1,650 mm), for Waterworks</i>	AWWA C906

Table 13.2.2.1 Fittings Material and Dimensions

Materials and Dimensions	Standard
Ductile Iron	
<i>Cement-Mortar Lining for Ductile-Iron Pipe and Fittings</i>	AWWA C104/A21.4
<i>Rubber-Gasket Joints for Ductile-Iron Pressure Pipe and Fittings</i>	AWWA C111/A21.11
<i>Flanged Ductile-Iron Pipe With Ductile-Iron or Gray-Iron Threaded Flanges</i>	AWWA C115
<i>Protective Fusion-Bonded Epoxy Coatings for the Interior and Exterior Surfaces of Ductile-Iron and Gray-Iron Fittings</i>	AWWA C116
CPVC	
<i>Standard Specification for Threaded Chlorinated Poly(Vinyl Chloride) (CPVC) Plastic Pipe Fittings, Schedule 80</i>	ASTM F437
<i>Standard Specification for Socket-Type Chlorinated Poly(Vinyl Chloride) (CPVC) Plastic Pipe Fittings, Schedule 40</i>	ASTM F438
<i>Standard Specification for Chlorinated Poly(Vinyl Chloride) (CPVC) Plastic Pipe Fittings, Schedule 80</i>	ASTM F439

- N 13.2.3.4.3** HDPE piping systems shall be properly supported and restrained.
- N 13.2.4 Valves.**
- N 13.2.4.1** Valves shall be in accordance with Section 4.5.
- N 13.2.4.2** Where required by the AHJ isolation valves shall be installed to separate individual docks or piers from main lines.
- N 13.2.4.3** Isolation valves shall be installed so that they are easily accessible.
- N 13.2.4.4** Isolation valves shall be marked as such on the surface of the dock.
- N 13.2.5 Hose Stations.** Hose stations shall be in accordance with Section 4.6.
- N 13.2.6 Hose Connections.** Hose connections shall be in accordance with Section 4.7.
- N 13.2.7 Fire Department Connections.** Fire department connections shall be in accordance with Section 4.8.
- N 13.2.8 Pressure-Regulating Devices.** Pressure-regulating devices shall be in accordance with Section 4.9.
- N 13.2.9 Signs.** Signs shall be in accordance with Section 4.10.
- N 13.3 System Requirements.**
- N 13.3.1** Unless otherwise required, Class I standpipe systems shall be installed.
- N 13.3.2*** Class I standpipe systems shall be permitted to be automatic dry, automatic wet, semiautomatic dry, manual dry, or manual wet.
- N 13.4 Installation.**
- N 13.4.1 Location and Protection of Piping.**
- N 13.4.1.1** Piping shall be permitted to be installed above or below piers, docks, and similar structures.
- N 13.4.1.2** Where nonmetallic pipe and fittings are used, no portion of the pipe shall extend above the surface of the water, unless otherwise protected from fire exposure.
- N 13.4.1.3** For other than water filled systems, where nonmetallic piping systems are installed on floating piers, the portion of the piping system that protrudes above the surface of the water shall be metallic piping of a type that resists corrosive environments.
- N 13.4.1.4** Where installed beneath the water surface, nonmetallic piping shall be installed in such a manner that maintenance of the piping system can be accomplished.
- N 13.4.1.5 Protection of System Piping.**
- N 13.4.1.5.1** System piping shall be protected from mechanical damage and fire damage in accordance with this section.
- N 13.4.1.5.2** Seismic bracing, where required, shall be in accordance with NFPA 13.
- N 13.4.1.5.3** Piping subject to mechanical damage shall be protected by steel posts, concrete barriers, or other approved means.
- N 13.4.1.5.4** Where corrosive conditions exist or piping is exposed to the weather, corrosion-resistant types of pipe, tube, fittings, and hangers or protective corrosion-resistive coatings shall be used.
- N 13.4.1.5.5** Where plastic piping is used, it shall be protected from fire exposure by fireproofing, concrete encasement, or other methods approved by the AHJ.
- N 13.4.1.5.6** Horizontal piping on manual dry systems and semi-automatic dry systems shall be pitched to drain at least ¼ in. per 10 ft (2 mm/m).
- N 13.4.1.5.7** Piping systems installed on floating marinas where the piping system is installed under water shall be equipped with an air blow-out to remove the water from the piping system using air pressure.
- N 13.4.1.6 Flexibility.**
- N 13.4.1.6.1** Where standpipes are installed on piers, docks, or similar structures that are subject to movement, the system piping shall have sufficient flexibility to account for the anticipated movement.
- N 13.4.1.6.2** Where piers, docks, or similar structures are subject to tidal movements, the flexibility shall take into account the maximum movement between mean low tide and high tide.
- N 13.4.1.6.3** Where standpipe systems are installed on floating docks or similar structures, there shall be sufficient flexibility to account for the maximum movement between sections of dock.
- N 13.4.1.6.4** The methods used to allow for movement of system piping shall be acceptable to the AHJ.
- N 13.4.2 Fire Department Connection.**
- N 13.4.2.1** Isolation valves shall not be permitted between the fire department connection and where the fire department connection piping connects to the system piping.
- N 13.4.2.2** A listed check valve shall be installed in each fire department connection and shall be located in an accessible location. [13:16.12.6.1]
- N 13.4.2.3 Location and Identification.**
- N 13.4.2.3.1** Fire department connections shall be visible and recognizable from the street or nearest point of fire department apparatus accessibility or on the street side of buildings.
- N 13.4.2.3.2** Fire department connections shall be located and arranged so that hose lines can be attached to the inlets without interference from nearby objects, including buildings, fences, posts, landscaping, vehicles, or other fire department connections.
- N 13.4.2.3.3** Each fire department connection shall be designated by a sign, with letters at least 1 in. (25.4 mm) in height, that reads "MANUAL DRY STANDPIPE," "MANUAL WET STANDPIPE," or "SEMI-AUTOMATIC DRY STANDPIPE" as applicable.
- N 13.4.2.3.4** A sign also shall indicate the pressure required at the inlets to deliver the standpipe system demand.
- N 13.4.2.3.5** Where a fire department connection services multiple piers, docks, or similar structures, a sign shall be provided indicating the piers, docks, or similar structures.

- N 13.4.2.3.6** Fire department connections shall be located not more than 100 ft (30.5 m) from the nearest fire hydrant or approved water supply.
- N 13.4.2.3.7** The location of the fire department connection shall be permitted to exceed 100 ft (30.5 m) subject to the approval of the AHJ.
- N 13.4.2.3.8** Fire department connections shall be located not less than 18 in. (457 mm) nor more than 48 in. (1219 mm) above the level of the adjoining ground, sidewalk, or grade surface.
- N 13.4.2.3.9** Fire department connection piping shall be supported in accordance with 13.4.3.
- N 13.4.2.3.10** Where required by the AHJ, a fire department connection accessible by fire boat shall be provided.
- N 13.4.3 Support of Piping.**
- N 13.4.3.1** Support of system piping shall be in accordance with NFPA 13 and this section.
- N 13.4.3.2** Methods for supporting system piping shall take into account corrosive conditions and exposure to the weather.
- N 13.4.3.3** Piers, docks, or similar structures shall be analyzed to support the calculated load of the standpipe system, prior to installation.
- N 13.4.4 Hydraulic Design Information Sign.**
- N 13.4.4.1** The installing contractor shall provide a sign identifying the basis of the system design.
- N 13.4.4.2** The sign shall be located at the water supply control valve for automatic or semiautomatic standpipe systems and at an approved location for manual systems.
- N 13.4.4.3** The sign shall indicate the following:
- (1) Location of the two hydraulically most remote hose connections
 - (2) Design flow rate for the connections identified in 6.8.3(1)
 - (3) Design residual inlet and outlet pressures for the connections identified in 6.8.3(1)
 - (4) Design static pressure and the design system demand (i.e., flow and residual pressure) at the system control valve, or at the pump discharge flange where a pump is installed, and at each fire department connection
- N 13.5 Design.**
- N 13.5.1 Location of Hose Connections.**
- N 13.5.1.1 General.**
- N 13.5.1.1.1** Hose connections and hose stations shall be unobstructed and shall be located not less than 3 ft (0.9 m) or more than 5 ft (1.5 m) above the walking surface where they are installed.
- N 13.5.1.1.2** This dimension shall be measured from the walking surface to the center of the hose valve.
- N 13.5.1.1.3** The hose connection shall not be obstructed.
- N 13.5.1.2 Class I Systems.** Where required to be provided, hose connections shall be located in accordance with 13.5.1.2.
- N 13.5.1.2.1** Hose connections shall be provided every 150 ft (45.7 m).
- N 13.5.1.2.2** Distance between hose connections shall be measured along the path of travel of the pier, dock, or similar structure.
- N 13.5.1.2.3** Hose connections shall be provided so that all portions of the walking surface of the pier, dock, or similar structure are within 130 ft (39.7 m) of a hose connection.
- N 13.5.2 Minimum Sizes for Standpipes and Branch Lines.**
- N 13.5.2.1** Standpipes shall be sized based on the hydraulic criteria established in 13.5.4 and 13.5.5 but shall be at least 4 in. (100 mm) in size.
- N 13.5.2.2** Branch lines shall be sized based on the hydraulic criteria established in 13.5.4 and 13.5.5 but not sized smaller than 2½ in. (65 mm).
- N 13.5.3 System Design and Sizing of Pipe for Delivery of System Demand.**
- N 13.5.3.1** Standpipe systems shall be designed so that the system demand can be supplied by each fire department connection, which is provided in accordance with 13.5.8.
- N 13.5.3.2** When the system demand to be supplied by the fire department at the fire department connection is being determined, the local fire department shall be consulted regarding the water supply available from a fire department pumper.
- N 13.5.4 Minimum Design Pressure for Hydraulically Designed Systems.** Hydraulically designed standpipe systems shall be designed to provide the waterflow rate required by Section 7.10 at a minimum residual pressure of 100 psi (6.9 bar) at the outlet of the hydraulically most remote 2½ in. (65 mm) hose connection and 65 psi (4.5 bar) at the outlet of the hydraulically most remote 1½ in. (40 mm) hose station.
- N 13.5.4.1** The pressure loss in the hose valve shall be calculated using Table 8.3.1.3 or the valve manufacturer's most up-to-date friction loss data when published.
- N 13.5.4.2** Standpipe systems shall be designed to provide 100 psi (6.9 bar) at the most remote outlet with the calculations terminating at the fire department connection.
- N 13.5.5 Flow Rates.**
- N 13.5.5.1** The minimum flow rate for the hydraulically most remote standpipe shall be 500 gpm (1893 L/min), through the two most remote 2½ in. (65 mm) outlets, and the calculation procedure shall be in accordance with 13.5.6.
- N 13.5.5.2** Where the system supplies three or more hose connections, the minimum flow rate for the hydraulically most demanding horizontal standpipe shall be 750 gpm (2840 L/min), and the calculation procedure shall be in accordance with 13.5.6.1.
- N 13.5.5.3** The minimum flow rate for additional standpipes shall be 250 gpm (946 L/min) per standpipe.
- N 13.5.5.4** The maximum flow rate shall be 1000 gpm (3785 L/min).
- N 13.5.6 Hydraulic Calculation Requirements.**
- N 13.5.6.1** Where a standpipe system supplies three or more hose connections on any pier, dock, or similar structure, hydraulic calculations and pipe sizes for each standpipe shall be based on providing 250 gpm (946 L/min) at the three

hydraulically most remote hose connections on the standpipe and at the most remote outlet of each of the other standpipes at the minimum residual pressure required by 13.5.4.

- N 13.5.6.2** Common supply piping shall be calculated and sized to provide the required flow rate for all standpipes connected to such supply piping, with the total not to exceed the maximum flow demand in 13.5.5.4.
- N 13.5.6.3** Common supply piping for separate standpipe systems shall be calculated to provide flow for the most demanding system.
- N 13.5.6.4** The maximum flow required from a 2½ in. (65 mm) hose connection shall be 250 gpm (946 L/min).
- N 13.5.7 Drains.** A means for draining the system shall be provided.
 - N 13.5.7.1** Auxiliary drains in accordance with NFPA 13 shall be provided for all portions of the standpipe system that cannot be drained from the main drain.
 - N 13.5.7.2** The requirements of 13.5.7.1 shall not apply where an air blow-out is installed in accordance with 13.4.1.5.7.
- N 13.5.8 Fire Department Connections.**
 - N 13.5.8.1** One or more fire department connections shall be provided for each standpipe system.
 - N 13.5.8.2** Fire department connection sizes shall be based on the standpipe system demand and shall include one 2½ in. (65 mm) inlet per every 250 gpm (946 L/min).
 - N 13.5.8.3** An approved large diameter hose connection of a size to accommodate the required flow shall be permitted.
 - N 13.5.8.4** The inlets required by 13.5.8.2 shall be permitted to be provided on multiple fire department connections.
 - N 13.5.8.5** The inlets required by 13.5.8.2 shall be permitted to be located in multiple locations as allowed by the AHJ.
- N 13.6 Plans and Calculations.** Plans and calculations shall be in accordance with Chapter 8.
- N 13.7 Water Supply.** Every standpipe system shall have an approved water supply accessible to a fire department pumper.
- N 13.8 Water Supply Testing.** Water supply testing shall be in accordance with Chapter 10.
- N 13.9 System Acceptance.**
 - N 13.9.1** System acceptance shall be in accordance with Chapter 11 and this section.
 - N 13.9.2** Pressure testing of HDPE systems shall be in accordance with ASTM F2164, *Standard Practice for Field Leak Testing of Polyethylene (PE) and Crosslinked Polyethylene (PEX) Pressure Piping Systems Using Hydrostatic Pressure*.
- N 13.10 System Inspection, Testing, and Maintenance.** A standpipe system installed in accordance with this chapter shall be properly inspected, tested, and maintained by the property owner or an authorized representative in accordance with NFPA 25 to provide at least the same level of performance and protection as originally designed.

Annex A Explanatory Material

Annex A is not a part of the requirements of this NFPA document but is included for informational purposes only. This annex contains explanatory material, numbered to correspond with the applicable text paragraphs.

A.1.1.2 See NFPA 25.

A.1.4 It is the intent of the committee to recognize that future editions of this standard are a further refinement of this edition and earlier editions. The changes in future editions will reflect the continuing input of the fire protection community in its attempt to meet the purpose stated in this standard. Compliance with all requirements of a future edition could be considered as providing an equivalent level of system integrity and performance of the system.

A.3.2.1 Approved. The National Fire Protection Association does not approve, inspect, or certify any installations, procedures, equipment, or materials; nor does it approve or evaluate testing laboratories. In determining the acceptability of installations, procedures, equipment, or materials, the authority having jurisdiction may base acceptance on compliance with NFPA or other appropriate standards. In the absence of such standards, said authority may require evidence of proper installation, procedure, or use. The authority having jurisdiction may also refer to the listings or labeling practices of an organization that is concerned with product evaluations and is thus in a position to determine compliance with appropriate standards for the current production of listed items.

A.3.2.2 Authority Having Jurisdiction (AHJ). The phrase "authority having jurisdiction," or its acronym AHJ, is used in NFPA documents in a broad manner, since jurisdictions and approval agencies vary, as do their responsibilities. Where public safety is primary, the authority having jurisdiction may be a federal, state, local, or other regional department or individual such as a fire chief; fire marshal; chief of a fire prevention bureau, labor department, or health department; building official; electrical inspector; or others having statutory authority. For insurance purposes, an insurance inspection department, rating bureau, or other insurance company representative may be the authority having jurisdiction. In many circumstances, the property owner or his or her designated agent assumes the role of the authority having jurisdiction; at government installations, the commanding officer or departmental official may be the authority having jurisdiction.

A.3.2.3 Listed. The means for identifying listed equipment may vary for each organization concerned with product evaluation; some organizations do not recognize equipment as listed unless it is also labeled. The authority having jurisdiction should utilize the system employed by the listing organization to identify a listed product.

A.3.3.2 Auxiliary Drain Connection. An auxiliary drain connection is not a main drain connection and is not intended to be used for testing the attached water supply. An auxiliary drain is also not intended to be operated under pressure.

N A.3.3.5 Construction Types. Refer to NFPA 5000 and NFPA 220 for clarification of construction types.

A.3.3.7.2 Horizontal Exit. The doorway from a rated corridor or area into a rated exit stairwell is not considered a horizontal exit. Sometimes an area of refuge can also be found in the

stairwell. A valve is required only in the stairwell, not on both sides of the door.

A.3.3.16 Pressure-Regulating Device. Examples include pressure-reducing valves, pressure control valves, and pressure-restricting devices.

A.3.3.16.1 Pressure-Reducing Valve. A pressure relief valve is not a pressure-reducing valve and should not be used as such.

A.3.3.20 Standpipe System. This arrangement is accomplished by means of connections to water supply systems or by means of pumps, tanks, and other equipment necessary to provide an adequate supply of water to the hose connections.

A.3.3.22 System Classes. NFPA 600 and the Fire Equipment Manufacturers Association (FEMA) are resources for training of personnel.

N A.3.3.26.1 Control Valve. Control valves do not include hose valves, inspector's test valves, drain valves, trim valves for dry pipe, preaction, and deluge valves, check valves, or relief valves.

A.4.1 The use of standard-weight valves and fittings ordinarily should be confined to the upper stories of very high buildings and to equipment in which the highest available pressures are less than 175 psi (12.1 bar).

A.4.1.3 Some common items that do not affect system performance are drain valves, drain piping, signs, and gauges.

N A.4.1.4.1 Certain devices, meters, and equipment that can be used to perform inspection and testing procedures from a distant location are not integral to the system and don't affect system performance. Automated inspection and testing devices and equipment, such as a digital camera, can be in the riser room or attached to the system externally but are not an integral part of the system. Such devices do not need to be listed.

N A.4.1.4.2 Certain devices and equipment that can be used to monitor system or component status from a distance are not integral to the system and don't affect system performance. Distance monitoring devices, such as an external thermometer, can be attached to the system externally and therefore are not subjected to system pressure. Such devices do not need to be listed.

A.4.3.5.1 There are many cases in which various sizes of fittings are referenced in a manufacturer's catalog but are not normally maintained in stock. Waiting for the manufacturer to produce fittings on special order can take several weeks. It is not the intent of this standard to force contractors to use fittings that are not available at the time of fabrication or installation, causing unnecessary delays in the project.

A.4.4.1.2 Some steel piping material having lesser wall thickness than specified in 4.4.1.2 has been listed for use in sprinkler systems where joined with threaded connections. The service life of such products can be significantly less than that of Schedule 40 steel pipe, and it should be determined if this service life will be sufficient for the application intended.

All such threads should be checked by the installer using working ring gauges conforming to the "Basic Dimensions of Ring Gauges for USA (American) Standard Taper Pipe Threads, NPT," as per Table 8 of ASME B1.20.1, *Pipe Threads, General Purpose (Inch)*. [13:A.7.5.1.2]

A.4.4.2.2 Cutting and welding operations account for 4 percent of fires each year in nonresidential properties and 8 percent in industrial and manufacturing properties. In-place welding of standpipe piping introduces a significant hazard that can normally be avoided by shop-welding the piping and installing the welded sections with mechanical fittings. As a result, the standard requires that all piping be shop-welded. When such situations cannot be avoided, the exceptions outline procedures and practices that minimize the increase in hazard. (See Figure A.4.4.2.2.)

A.4.4.2.3.1 Listed, shaped, and contoured nipples meet the definition of fabricated fittings. [13:A.7.5.2.3.1]

A.4.4.2.4.1 Partial penetration welds on outlet fitting connections are considered adequate, since there is no significant load on the joint other than that caused by pressure internal to the pipe (see Figure A.4.4.2.4.1). [13:A.7.5.2.4.1]

The load due to the internal pressure can be accommodated with a weld that has a conservative weld throat thickness that can be calculated as follows:

[A.4.4.2.4.1]

$$\text{Weld throat thickness (in.)} = PD \times 0.000035$$

where:

P = rated system gauge pressure (psi)

D = outside diameter (OD) of fitting (in.)

[13:A.7.5.2.4.2]

For example: If you assume a pressure of 300 psi (21 bar) and the OD of the outlet fitting of 3 in. (75 mm), the result of the thickness calculation is 0.0315 in. (0.8 mm). When compared to the minimum throat thickness of $\frac{3}{16}$ in. (5 mm), there is a factor of more than 5 times the calculated thickness value. [13:A.7.5.2.4.2]

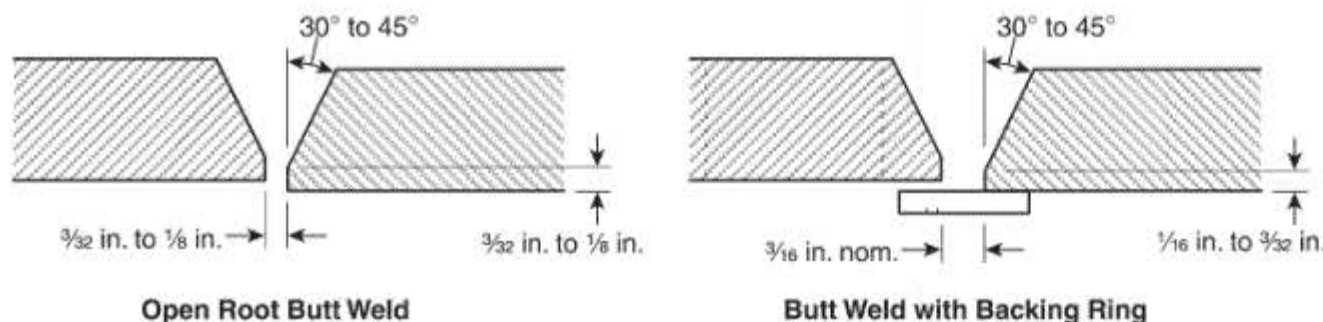
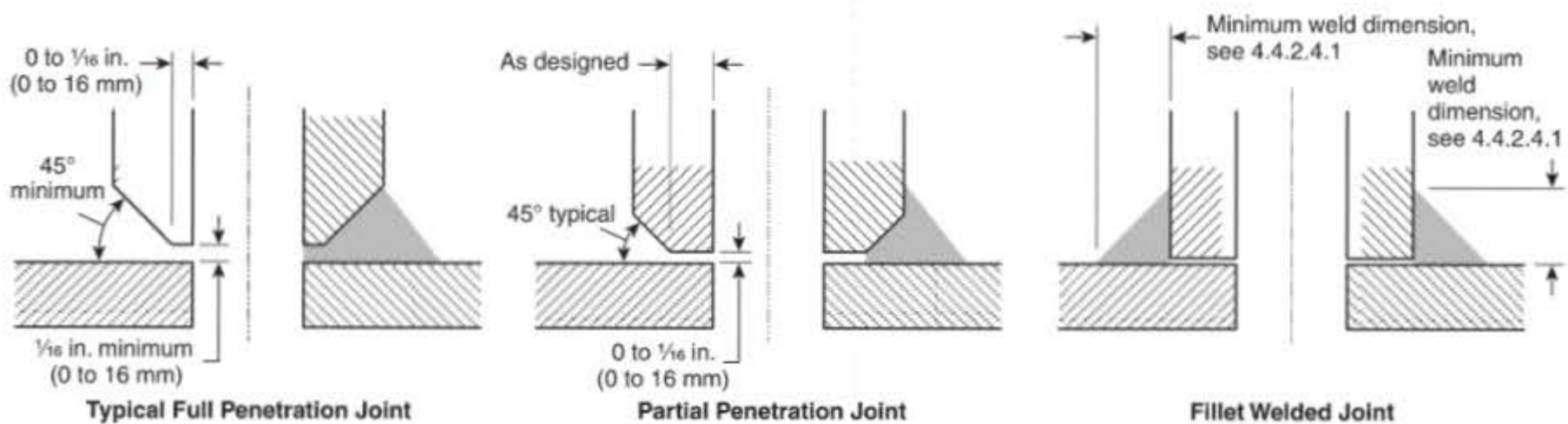

FIGURE A.4.4.2.2 Weld Diagram.



▲ FIGURE A.4.4.2.4.1 Weld Descriptions. [13:Figure A.7.5.2.4.1]

A.4.4.2.4.3 The preparation of mating surfaces is important to the proper fabrication of a weld joint. To accomplish this, the mating surfaces for a circumferential butt weld joint should be prepared and configured so that a full penetration weld is achievable, but a partial penetration weld is acceptable. [13:A.7.5.2.4.3]

A.4.4.4 The fire hazard of the brazing process should be suitably safeguarded.

A.4.6.2.1 One method of determining adequately trained personnel is described in NFPA 600.

A.4.6.5 One method of determining adequately trained personnel is described in NFPA 600.

A.4.7.5 It is important to provide adequate clearance for the valve handle so that a fire fighter using a gloved hand can quickly open and close a hose valve. Subsection 4.7.5 does not pertain to hose valves located in closets and cabinets.

A.5.1.2 The need for a standpipe system and some design elements will normally come from the jurisdiction's adopted building code and fire prevention code. Design of standpipe systems should include consideration of local fire department suppression tactics, hose size, hose length, and types of nozzles used.

A.5.2.1 A dry pipe system should be installed only where heat is not adequate to prevent freezing of water in all parts of, or in sections of, the system. [13:A.8.2]

A.5.2.1.2.1 The capacities of the various sizes of pipe given in Table A.5.2.1.2.1 are for convenience in calculating the capacity of a system. [13:A.8.2.3]

A.5.2.1.3 The dry pipe valve should be located in an accessible place near the system it controls. Where exposed to cold, the dry pipe valve should be located in a valve room or enclosure of adequate size to properly service equipment. [13:A.8.2.5]

A.5.2.1.3.1 The dry pipe valve and supply piping should be in an area maintained at or above 40°F (4°C). It is the intent of the committee to protect the valves from freezing. The occasional exposure of valves to short exposures of air temperatures below 40°F (4°C) that would not cause the valves to freeze does not justify the construction of a valve room. [13:A.8.2.5.1]

A.5.2.1.4.2 The compressor should draw its air supply from within the operating criteria allowed by the manufacturer of the compressor. Air piping should not be attached to the intake of the compressor unless acceptable to the compressor manu-

▲ Table A.5.2.1.2.1 Capacity of 1 Foot of Pipe (Based on Actual Internal Pipe Diameter)

Nominal Pipe Diameter (in.)	Pipe	
	Schedule 40 (gal)	Schedule 10 (gal)
3/4	0.028	
1	0.045	0.049
1 1/4	0.078	0.085
1 1/2	0.106	0.115
2	0.174	0.190
2 1/2	0.248	0.283
3	0.383	0.433
3 1/2	0.513	0.576
4	0.660	0.740
5	1.040	1.144
6	1.501	1.649 ^b
8	2.66 ^a	2.776 ^c

For SI units, 1 in. = 25.4 mm; 1 ft = 0.3048 m; 1 gal = 3.785 L.

^aSchedule 30.

^b0.134 wall pipe.

^c0.188 wall pipe.

[13:Table A.8.2.3]

facturer. Damage, air reduction, or reduced life expectancy can result if guidelines are not followed.

A.5.2.1.4.2.2 When a single compressor serves multiple dry pipe systems, the 30-minute fill time is based on the single largest system. [13:A.8.2.6.3.2]

A.5.2.3 A dry pipe system should be installed only where heat is not adequate to prevent freezing of water in all parts of, or in sections of, the system.

A.5.2.3.1.3 Remote control activation circuits should not be placed in unsprinklered areas of combustible construction.

A.5.4 The committee's intent is to permit the omission of a fire pump as part of the standpipe system in non-high-rise buildings where the automatic sprinkler system can be designed and installed with the available water supply and the flow and pressure demands of the standpipe system can be provided by the fire department apparatus through the fire department connection.

A.5.4.1.1 A fire pump can be installed to supply the sprinkler demand and inside hose requirements only. The fire pump is not required to supply the manual wet standpipe system demand at the most remote hose connections.

A.5.4.2.1 A manual wet standpipe system can be used to satisfy the demand for a Class III system as long as the water supply can provide 100 gpm at 65 psi (379 L/min at 4.5 bar) to the most remote 1½ in. (40 mm) hose connection. The fire department can provide the rest of the demand through the fire department connection.

A.5.5 Additional pressure gauges located at the base of the standpipes might be desirable in some equipment, particularly in large plants and high-rise buildings.

A.5.5.2 It is the intent of the standard that pressures can be read on each floor where pressure-regulating devices are installed and that a valved outlet be provided for a pressure gauge. A permanently installed pressure gauge is not required.

A.5.6 Audible alarms are normally located on the outside of the building. Approved electric gong bells, horns, or sirens located inside the building or both inside and outside are sometimes advisable.

A.5.6.4 It is acceptable to utilize a hose valve on the standpipe to test the waterflow device as long as the water is dispersed to an acceptable location. This could be done with a hose valve on the roof or by using a hose connected to a hose valve discharging to a suitable location.

A.6.1 Connections from fire pumps and sources outside the building should be made at the base of the standpipes.

A.6.1.2.1 Standpipes should not be installed in nonsprinklered areas of combustible construction.

▲ A.6.1.2.2 Protection of pipe should be provided in any area of a structure or building that poses a degree of hazard greater than that normal to the general occupancy of the building or structure. This includes areas for the storage or use of combustibles or flammables; toxic, noxious, or corrosive materials; and heat-producing appliances.

A.6.1.2.3.2.2 The standards for the listing of heat tracing should include supervision of the following items:

- (1) Ground fault
- (2) Low system temperature
- (3) High system temperature
- (4) Temperature sensor failure
- (5) Primary controller failure
- (6) Electrical continuity
- (7) Loss of incoming supply voltage
- (8) Engagement of secondary controller

A.6.3.1.5 Manual wet standpipe systems can be installed by themselves or as part of a combination system. Usually with a combination system, there will be the required valves as part of the sprinkler system requirements from either NFPA 13 or NFPA 13R. In systems with only a manual wet standpipe, connection to any readily available water source is acceptable. The control and check valves only need to be approved. A common scenario is to connect the system to the potable water system, which could require some form of cross connection control, which might satisfy the valving requirement. There is no minimum size requirement for this connection.

A.6.3.5 See Figure A.6.3.5(a) and Figure A.6.3.5(b).

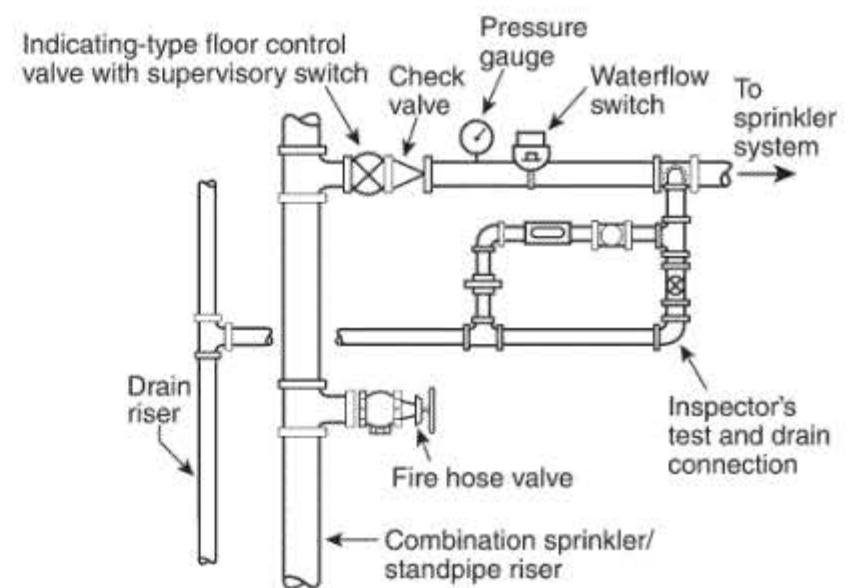

FIGURE A.6.3.5(a) Acceptable Piping Arrangement for Combined Sprinkler/Standpipe System.

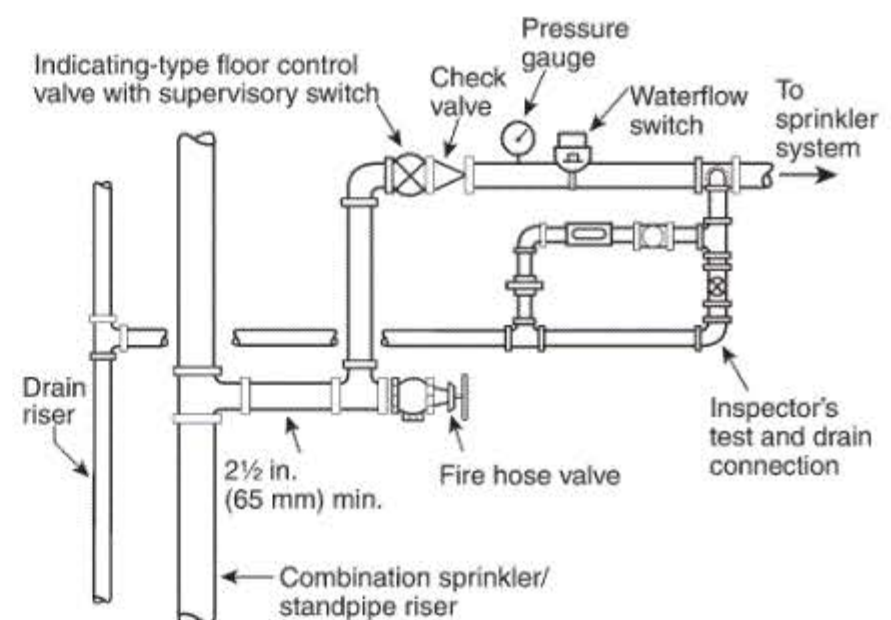

FIGURE A.6.3.5(b) Combined Sprinkler/Standpipe System.

A.6.3.6.1.1 A water supply connection should not extend into a building or through a building wall unless such connection is under the control of an outside listed indicating valve or an inside listed indicating valve located near the outside wall of the building.

All valves controlling water supplies for standpipe systems or portions thereof, including floor control valves to sprinkler systems and standpipe isolation valves, should be accessible to authorized persons during emergencies. Permanent ladders, clamped treads on risers, chain-operated hand wheels, or other accepted means should be provided where necessary.

Outside control valves are suggested in the following order of preference:

- (1) Listed indicating valves at each connection into the building at least 40 ft (12.2 m) from buildings if space permits
- (2) Control valves installed in a cutoff stair tower or valve room accessible from outside
- (3) Valves located in risers with indicating posts arranged for outside operation
- (4) Key-operated valves in each connection into the building

A.6.3.8.5 Depending on the arrangement of the hose connection in a corridor or large area, it can be preferable to mount hose connection identification signs parallel, perpendicular, or at an angle to the plane of the mounting surface on which the sign is located.

A.6.4 See Figure A.6.4 for general arrangement.

A.6.4.4 In cases where water in the piping between the system side and the fire department connection check valve would be trapped, an auxiliary drain is required.

A.6.4.5.4 The system designer should contact the AHJ prior to establishing the location of the fire department connection. The location should be based on the requirements of the fire department.

A.6.8 See Figure A.6.8 for a sample hydraulic design information sign.

A.7.1 The building height determines the number of vertical zones. The area of a floor or fire area and exit locations, as well as the occupancy classification, determines the number and locations of hose connections. Local building codes influence types of systems, classes of systems, and locations of hose connections. Pipe sizing is dependent on the number of hose connections flowing, the quantity of water flowed, the required

residual pressure, and the vertical distance and horizontal distance of those hose connections from the water supplies.

For typical elevation drawings, see Figure A.7.1(a), Figure A.7.1(b), Figure A.7.1(c), and Figure A.7.1(d). See Chapter 7 for general system requirements.

A.7.1.1 It is important to determine the exact operating range to ensure that pressure-regulating devices function in accordance with the manufacturer's instructions for both maximum and minimum anticipated flow rates. Minimum flow can be from a single sprinkler for combined systems or flow from a 1½ in. (40 mm) hose connection on standpipe systems that do not supply sprinklers. This could require the use of two devices installed in parallel.

A.7.2 The system pressure limits have been implemented to replace the former height units. Because the issue addressed by the height limits has always been maximum pressure, pressure limitations are a more direct method of regulation and allow flexibility in height units where pumps are used, because a pump curve with less excess pressure at churn yields lower maximum system pressures while achieving the required system demand.

The maximum system pressure normally is at pump churn. The measurement should include both the pump boost and city static pressures. The 400 psi (27.2 bar) limit was selected because it is the maximum pressure at which most system components are available, and it recognizes the need for a reasonable pressure unit.

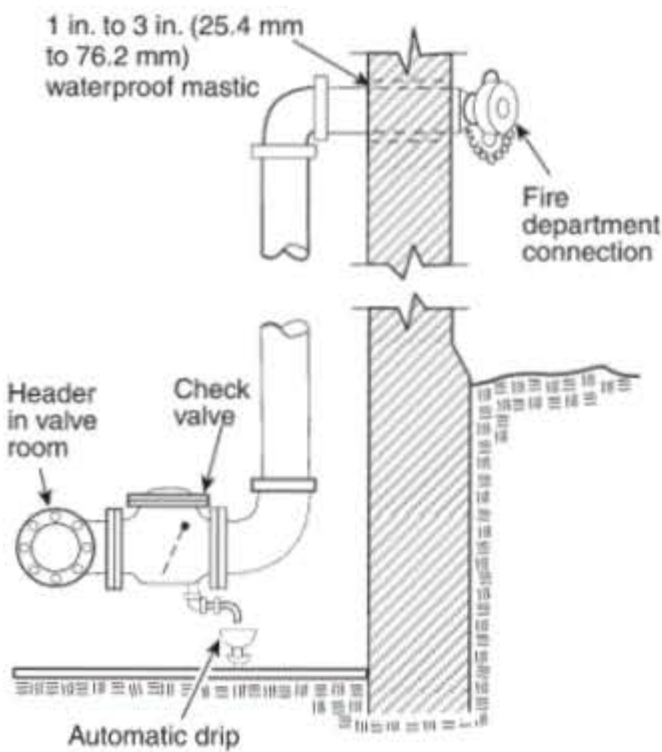

FIGURE A.6.4 Typical Fire Department Connection for Wet Standpipes.

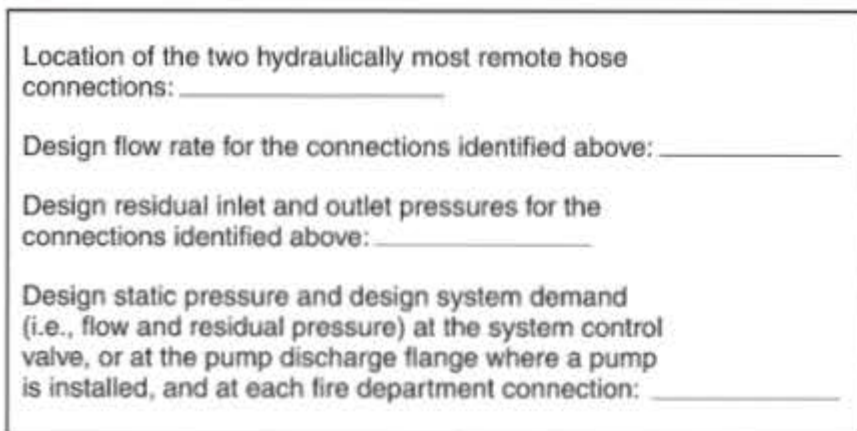
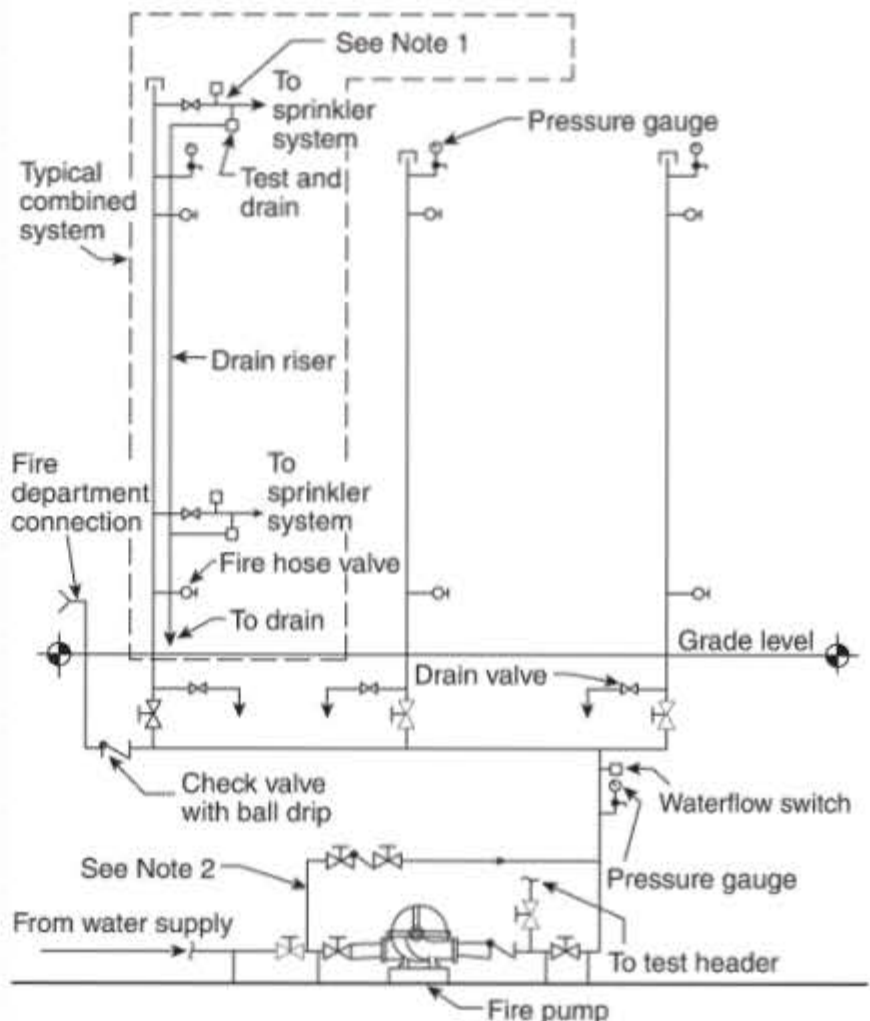
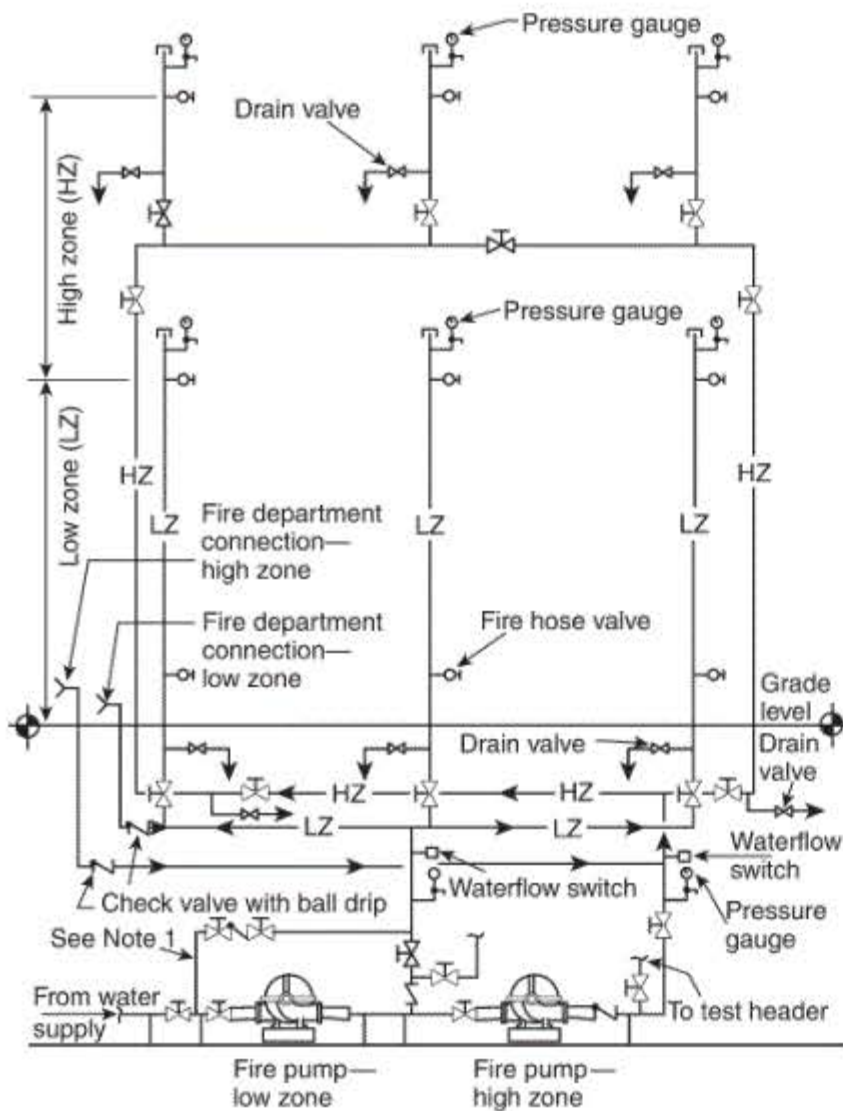

FIGURE A.6.8 System Hydraulic Design Information Sign.



- Notes:
1. Sprinkler floor assembly in accordance with NFPA 13, *Standard for the Installation of Sprinkler Systems*.
 2. Bypass in accordance with NFPA 20, *Standard for the Installation of Stationary Pumps for Fire Protection*.

FIGURE A.7.1(a) Typical Single-Zone System.



Notes:

1. Bypass in accordance with NFPA 20, *Standard for the Installation of Stationary Pumps for Fire Protection*.
2. High zone pump can be arranged to take suction directly from source of supply.

FIGURE A.7.1(b) Typical Two-Zone System.

A.7.2.3 Due to the different pressure limitations established in Section 7.2, it might be necessary to arrange piping so that separate pressure-regulating devices can be provided on the Class I and Class II hose connections.

For Class I standpipes, a pressure-regulating device should not be required where the static pressure of a hose connection exceeds 175 psi (12.1 bar), provided that downstream components, including fire hose and fire nozzles of the responding fire suppression company, are rated for the anticipated static and residual pressures, subject to approval by the AHJ. Due to the inherent safety issues of higher pressure, the AHJ should determine that the fire department is trained in the use of higher pressure hose and nozzles.

A.7.2.3.2 Where the building fire department connections are inaccessible or inoperable, many fire departments lay a hose-line from the pumper into the building and connect to an accessible valve outlet using a double female swivel. To pressurize the standpipe, the hose valve is opened and the engine pumps into the system.

If the standpipe is equipped with pressure-reducing hose valves, the valve acts as a check valve, prohibiting pumping into the system when the valve is open.

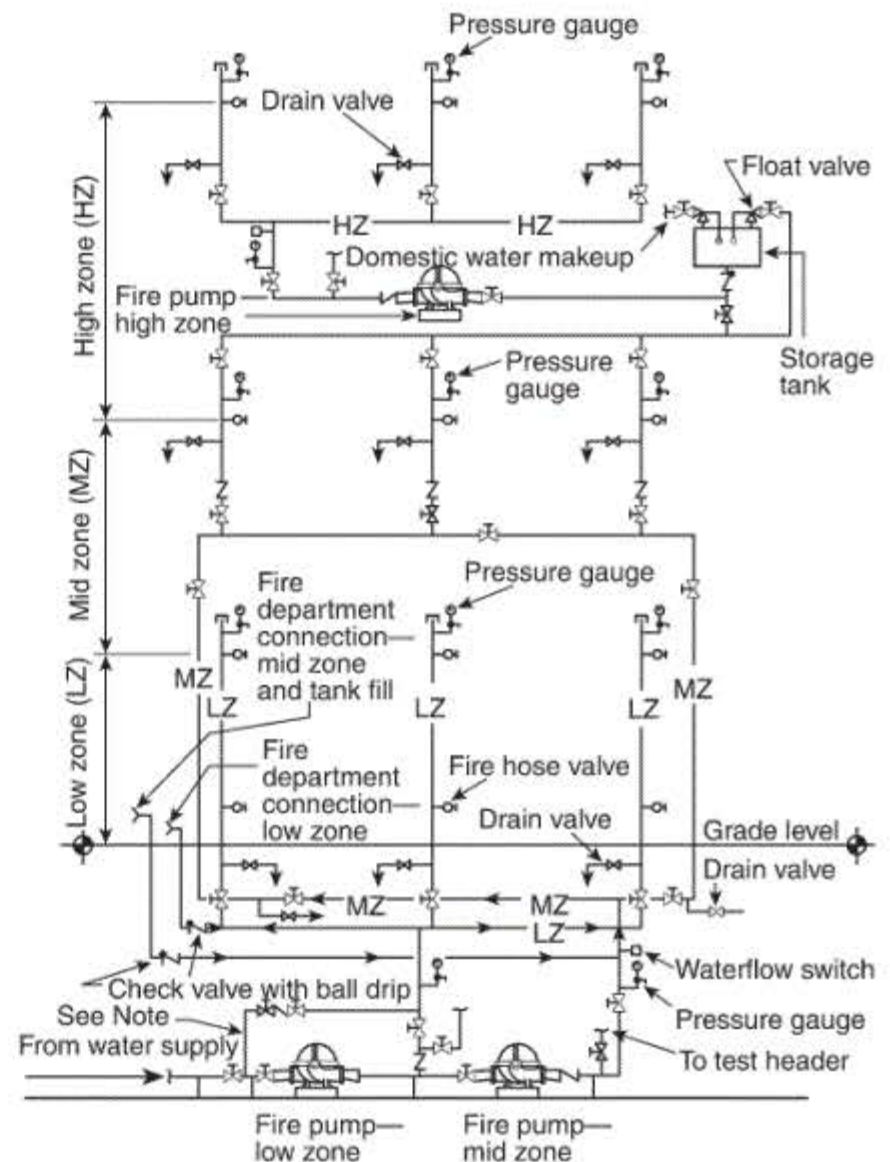

Note: Bypass in accordance with NFPA 20, *Standard for the Installation of Stationary Pumps for Fire Protection*.

FIGURE A.7.1(c) Typical Multizone System.

A supplementary single-inlet fire department connection or hose valve with female threads at an accessible location on the standpipe allows pumping into that system.

A.7.2.4 A small diameter pressure-reducing device can be required due to the minimum listed flow for large diameter pressure-reducing devices typically exceeding low flow conditions, to accommodate low flow conditions such as those created by the flow of a 1½ in. (40 mm) hose connection or a single sprinkler on a combined system. These should also be arranged such that the failure of a single device does not allow pressure in excess of 175 psi (12.1 bar) to more than two hose connections.

See Figure A.7.2.4 for one method to comply with 7.2.4. Alternate methods are acceptable as long as they comply with all the requirements of 7.2.4.

A.7.3.1 Hose can be permitted to be located at one side of the standpipe and supplied by short lateral connections to the standpipe where necessary to avoid obstructions.

Hose connections for Class I systems should be located in a stairway enclosure, and connections for Class II systems should be located in the corridor or space adjacent to the stairway enclosure and connected through the wall to the standpipe. For Class III systems, the connections for 2½ in. (65 mm) hose should be located in a stairway enclosure, and Class II connections should be located in the corridor or space adjacent to the

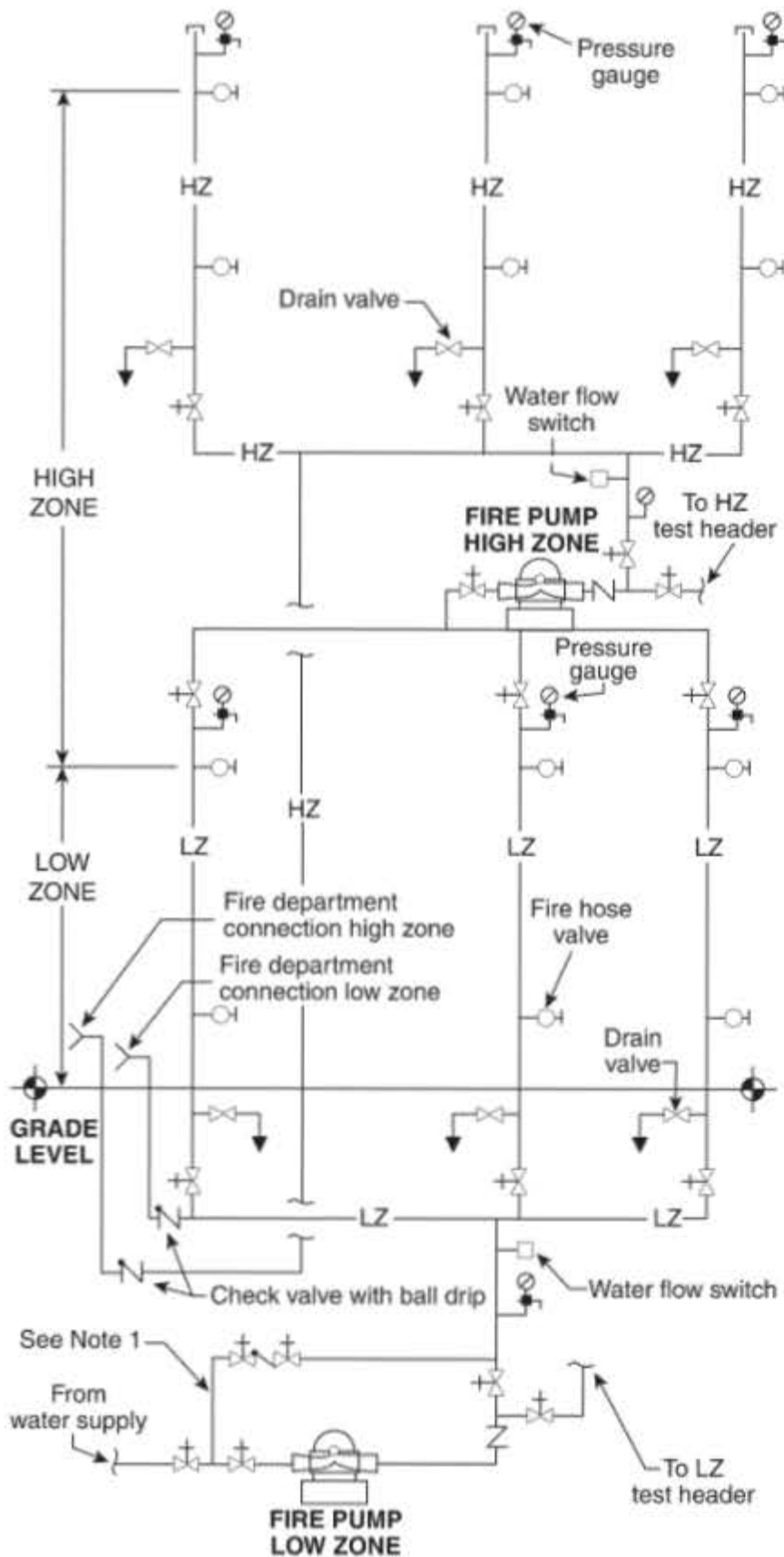

Note: Bypass in accordance with NFPA 20, *Standard for the Installation of Stationary Pumps for Fire Protection*.

FIGURE A.7.1(d) Vertically Staged Pumps for Two-Zone System.

stairway enclosure. These arrangements make it possible to use Class II system hose streams promptly in case the stairway is filled with people who are escaping at the time of fire. In buildings having large areas, connections for Class I and Class III systems can be located at interior columns.

A.7.3.2 Hose connections are now specified to be located at the main floor landing in exit stairways. Paragraph 7.3.2.1 permits hose connections to be located at intermediate landings where local fire-fighting tactics require this location. Only one standpipe is necessary to serve the roof regardless of the

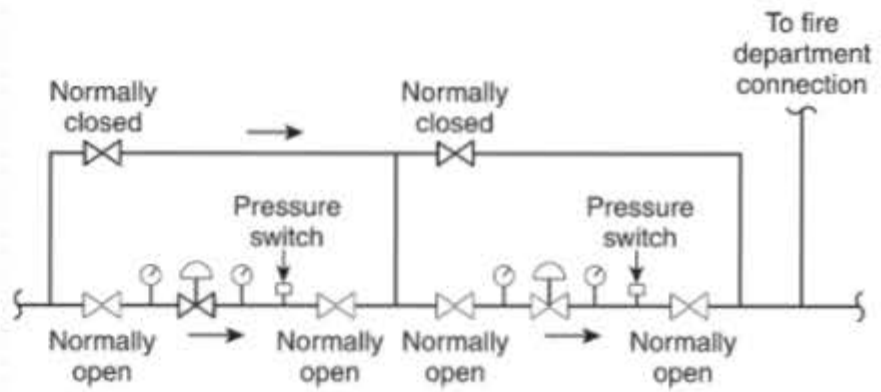

Note: FDC required downstream of pressure-regulating device but not required immediately adjacent thereto.

FIGURE A.7.2.4 Dual Pressure-Regulating Device Arrangement.

travel distances in 7.3.2.2; it is not the intent to extend each standpipe to the roof level.

The approach to locating hose connections with respect to exits is shown in Figure A.7.3.2(a), Figure A.7.3.2(b), and Figure A.7.3.2(c).

A.7.3.2.1.1 When locating hose connections on the main or intermediate landings, egress clearances as required by other codes need to be considered.

A.7.3.2.2 Paragraph 7.3.2.2 is intended to provide local fire departments with the authority to require additional hose connections outside of or away from a 2-hour fire-resistive separation. These additional hose connections could be needed to allow fire fighters to attach a fire hose in a reasonable time frame, based on the lengths of hose available on fire department standpipe packs or in carry bags. While it is recognized that hose connection spacing limitations provide controls to limit the maximum hose length needed to fight a fire, thereby minimizing the physical demands on fire fighters, it is also recognized that, in some cases, based on architectural layout, additional hose connections could be needed in open floor areas in order to meet spacing requirements. In such cases, such hose connections are unlikely to be utilized, since there would not be a staging area for fire fighters to use when accessing the hose connection. Therefore, additional hose connections, where provided to meet distance requirements, would be

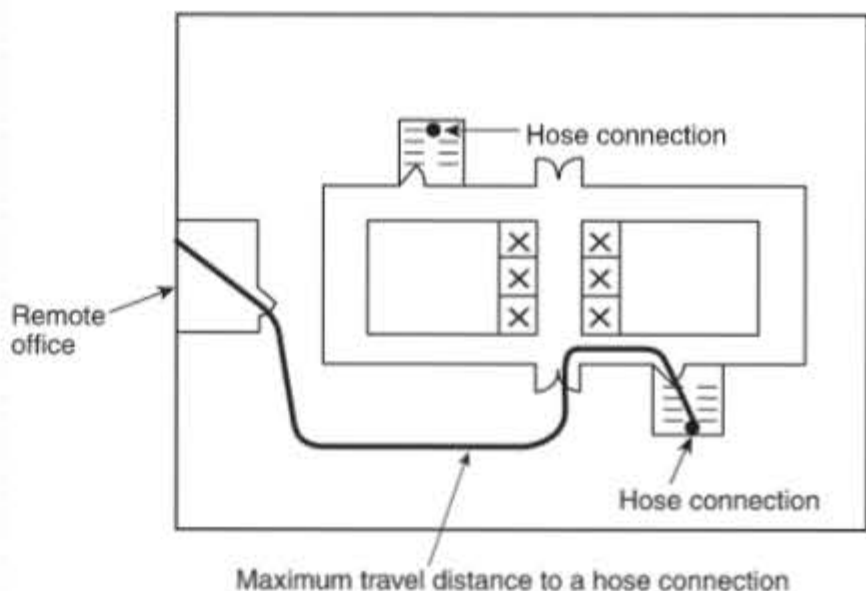

FIGURE A.7.3.2(a) Location of Hose Connections in Stairwells.

located in 1-hour fire-resistive exit corridors wherever possible, to provide a degree of protection for fire fighters accessing the connection. Such connections also should be located as uniformly as possible from floor to floor so that fire fighters can find them easily during a fire.

The 200 ft (61 m) distance allowed for sprinklered buildings could necessitate additional hose lengths in order to reach the most remote portion of a floor; however, automatic sprinklers should provide adequate control to allow time for fire fighters to extend hoses in those cases where a fire is located in the most remote area.

A.7.3.2.2.1 See Figure A.7.3.2.2.1.

Δ A.7.3.2.5 Paragraph 7.3.2.1 requires that a standpipe be provided in each required exit stairwell. One arrangement that might be found in certain residential buildings is that two remotely located exit stairs provide the occupants two distinct means of egress. This section allows a single hose connection to be located anywhere between the exit stairs, provided the exit stairs are open and are located within 75 ft (23 m) of each other. (See Figure A.7.3.2.5.)

A.7.3.2.7 Access to the roof can be via a stairwell that terminates at the roof level. Access could also be a permanent ladder, permanent ladder rungs, or a pull-down stair with a

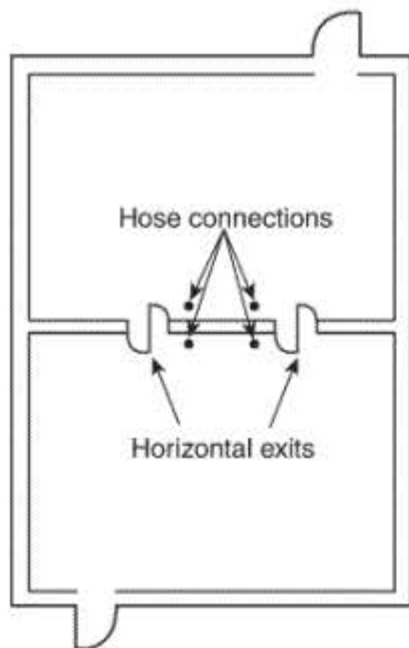

FIGURE A.7.3.2(b) Location of Hose Connections at Horizontal Exits.

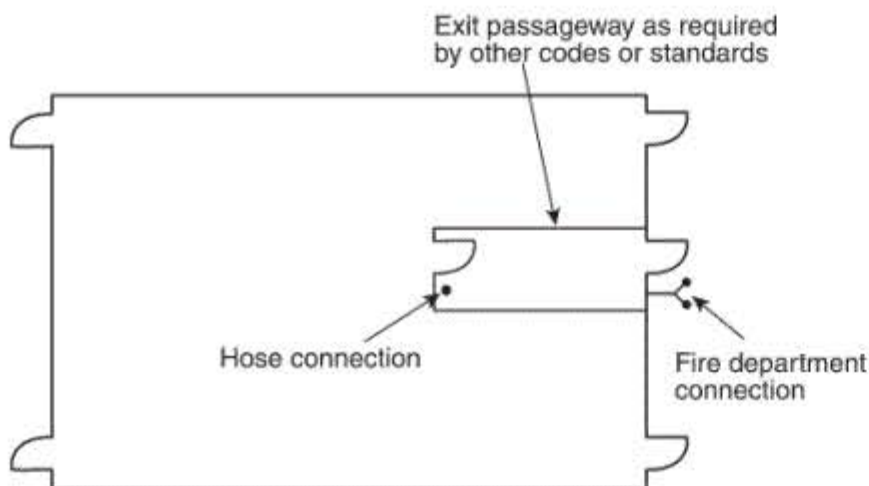
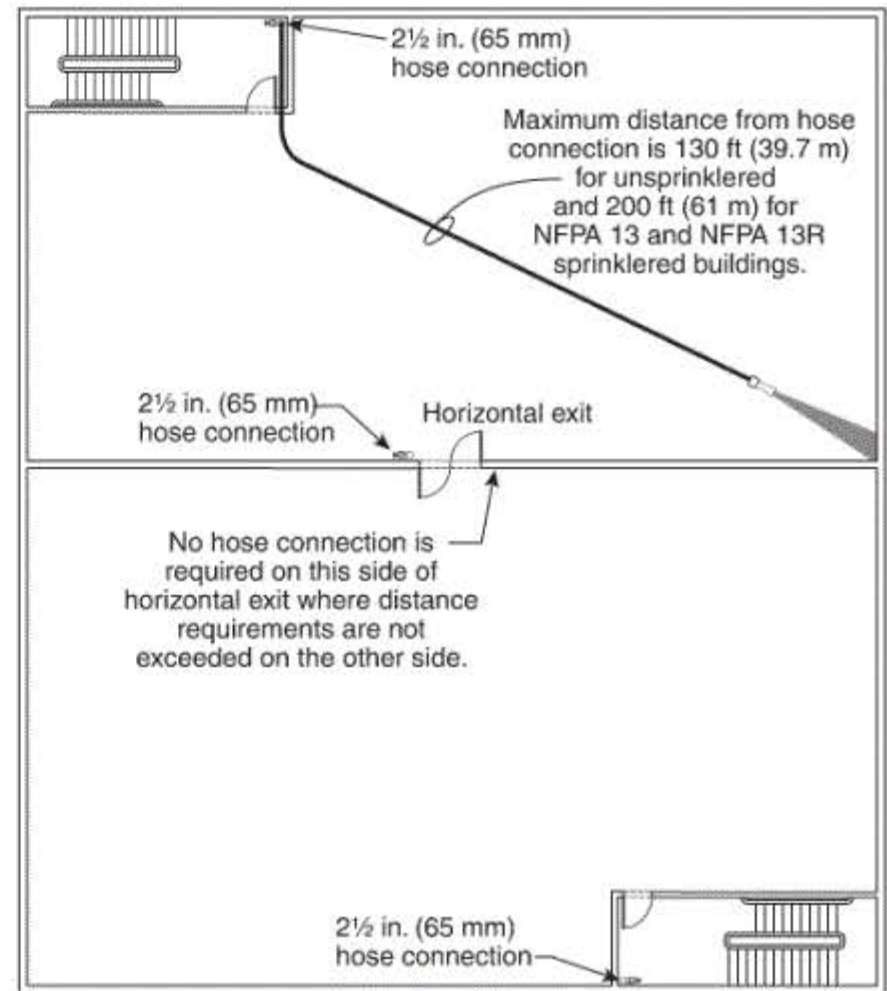

FIGURE A.7.3.2(c) Location of Hose Connections in Exit Passageways.



Δ FIGURE A.7.3.2.2.1 Location of Hose Connections at Horizontal Exits and Stairwells.

roof hatch. See Figure A.7.3.2.7 for an example of a roof hose connection in areas subject to freezing. The isolation valve will be in the normally closed position.

A.7.3.2.8 It is not necessary to provide an additional hose valve at the top of the stairwell at the main landing where the fire department procedures utilize hose connections on intermediate landings. The intermediate landing is usually located in close proximity to the top of the stairwell.

A.7.3.2.10 Paragraph 7.3.2.10 is intended to provide local fire departments with the authority to require additional hose connections outside of or away from locations required in 7.3.2. These additional hose connections could be needed to allow fire fighters to attach a fire hose in a reasonable time frame, based on the lengths of hose available on fire department standpipe packs or in carry bags. While it is recognized that hose connection spacing limitations provide controls to limit the maximum hose length needed to fight a fire, thereby minimizing the physical demands on fire fighters, it is also recognized that in some cases, based on architectural layout, additional hose connections could be needed in open floor areas in order to meet spacing requirements. In those cases, such hose connections are unlikely to be utilized, since there would not be a staging area for fire fighters to use when accessing the hose connection. Therefore, additional hose connections, where provided to meet distance requirements, should be located in 1-hour fire-resistive exit corridors wherever possible, to provide a degree of protection for fire fighters accessing the connection. Such connections also should be located as uniformly as possible from floor to floor so that fire fighters can find them easily during a fire.

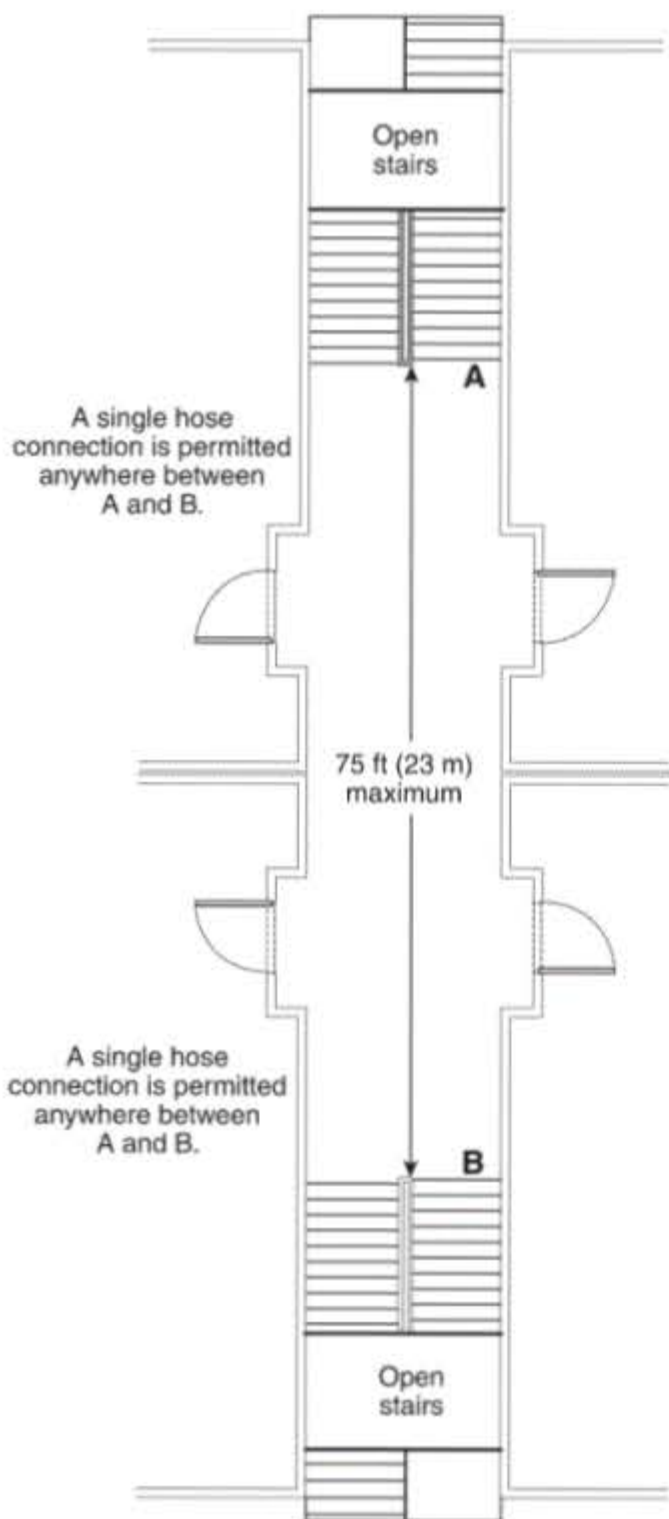

▲ FIGURE A.7.3.2.5 Single Hose Valve in Open Stairs/Corridors.

A.7.3.2.11 Paragraph 7.3.2.11 is intended to provide local fire departments with the authority to require additional hose connections outside of or away from locations required in 7.3.2. These additional hose connections could be needed to allow fire fighters to attach a fire hose in a reasonable time frame, based on the lengths of hose available on fire department standpipe packs or in carry bags. While it is recognized that hose connection spacing limitations provide controls to limit the maximum hose length needed to fight a fire, thereby minimizing the physical demands on fire fighters, it is also recognized that in some cases, based on architectural layout, additional hose connections could be needed in open floor areas in order to meet spacing requirements. In those cases, such hose connections are unlikely to be utilized, since there would not be a staging area for fire fighters to use when accessing the hose connection. Therefore, additional hose connections, where provided to meet distance requirements, should be located in 1-hour fire-resistive exit corridors wherever possi-

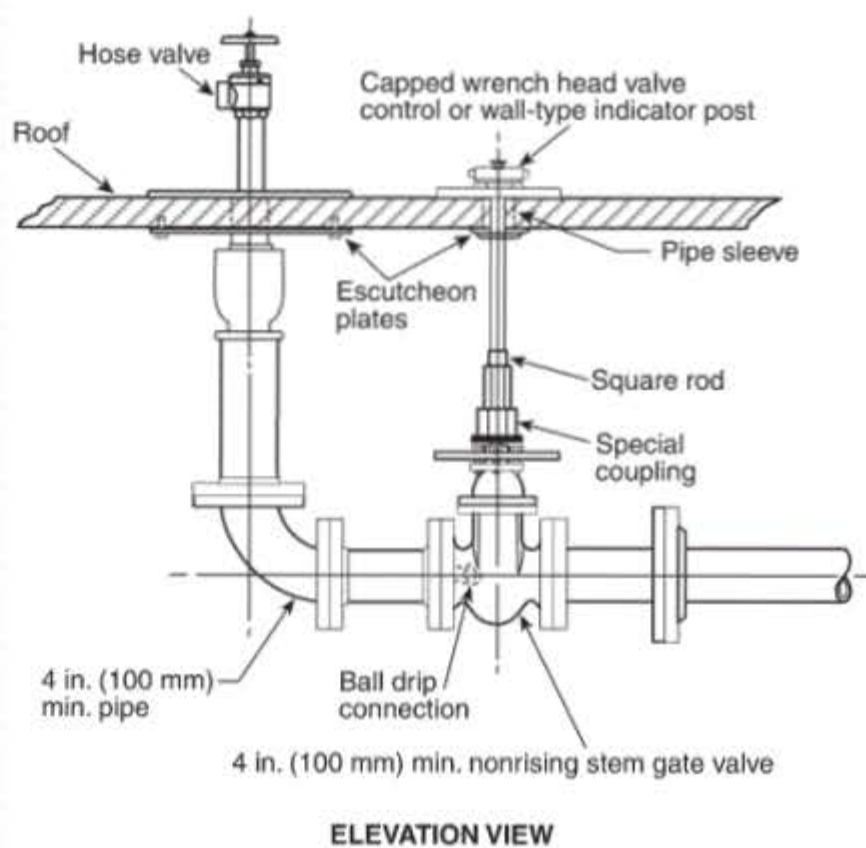

FIGURE A.7.3.2.7 Roof Hose Connection Piping Arrangement.

ble to provide a degree of protection for fire fighters accessing the connection. Such connections also should be located as uniformly as possible from floor to floor so that fire fighters can find them easily during a fire. The 200 ft (61 m) distance allowed for sprinklered buildings could necessitate additional hose lengths in order to reach the most remote portion of a floor; however, automatic sprinklers should provide adequate control to allow time for fire fighters to extend hoses in those cases where a fire is located in the most remote area.

A.7.3.3 Hose stations should be so arranged as to allow discharge to be directed from the nozzle into all portions of important enclosures such as closets and similar enclosures.

A.7.5 Fire department connections feeding interconnected standpipes, including combined systems, should be arranged to supply all interconnected standpipes in a building or section of a building. See Figure A.7.1(a), Figure A.7.1(b), and Figure A.7.1(c). Interconnection should occur as close to the source of supply(ies) as possible.

Standpipe systems in separate buildings or structures fed by the same water supply are not required to be interconnected. For example, a building might have an automatic-wet standpipe system while an adjacent parking garage has an automatic-dry standpipe system fed by the same fire pump and water main. These two standpipe systems are not required to be interconnected since they protect different structures.

A.7.7.2 Hydraulic calculations should be provided to show that each fire department connection can adequately supply the standpipe demand.

▲ A.7.8 Where determining the pressure at the remote hose connection, the pressure loss in the hose valve should be considered.

It is very important that fire departments choose an appropriate nozzle type for their standpipe fire-fighting operations.

Constant pressure- (automatic-) type spray nozzles (*see NFPA 1964*) should not be used for standpipe operations because many of these types require a minimum of 100 psi (6.9 bar) of pressure at the nozzle inlet to produce a reasonably effective fire stream. In standpipe operations, hose friction loss could prevent the delivery of 100 psi (6.9 bar) or 75 psi (5.2 bar) to the nozzle. Additionally, the use of spray-type nozzles does not allow for the passage of debris and sediment found in standpipe systems, which will lead to significant reduction or complete cessation of flow from the nozzle. The use of smooth bore nozzles allows the passing of debris and sediment.

In high-rise standpipe systems with pressure-reducing hose valves, the fire department has little or no control over hose valve outlet pressure. The use of gate valves and in-line pressure gauges is needed to allow for the fire department to maintain positive control of the hose connection and the flow pressure on operating hand lines.

The minimum flow and pressure design of standpipe hose connections are based on 2½ in. (65 mm) hose lines and smooth bore nozzles. Any other combination of hose or nozzles should be flow tested and verified to operate at the minimum design characteristics for hose connections. Many fire departments use combination (fog and straight stream) nozzles requiring 100 psi (6.9 bar) residual pressure at the nozzle inlet with 1½ in., 1¾ in., or 2 in. (40 mm, 44 mm, or 50 mm) hose in lengths of 150 ft (45.7 m). Additionally, it should be considered that with current longer travel distances and the practice of hooking up on the floor below, hose line lengths of 200 ft (61 m) and longer should be anticipated. This increases the impact of friction loss with the use of hose lines smaller than 2½ in. (65 mm).

Some departments use 50 ft (15.2 m) of 2½ in. (65 mm) hose to a gated wye, supplying two 100 ft (30.5 m) lengths of 1½ in. to 2 in. (40 mm to 50 mm) hose with combination nozzles, requiring 120 psi to 149 psi (8.3 bar to 10.3 bar) at the valve outlet. The use of gated wyes can also exceed the design flow rate for an individual standpipe hose connection and should also be flow tested to determine the needed pressure and flow to operate safely.

See Table A.7.8 for possible combinations of hose and nozzles found in use. It should be noted that the friction loss in fire hose can vary greatly from manufacturer to manufacturer. Flow testing should be conducted by the fire department in order to determine the flow and pressure requirements of the hose/nozzle combination of choice. See also NFPA 1901.

A.7.8.1.2 It is not the intent of this standard to provide an automatic water supply for manual standpipe systems. Manual standpipe systems are designed (sized) to provide 100 psi (6.9 bar) at the topmost hose connection using a fire department pumper as the source of flow and pressure.

A.7.9 Standpipe system zones are intended to limit system design pressures to not more than 400 psi (27.2 bar) or within the system component pressure ratings as required by Section 7.2. It is the intent of Section 7.9 to provide for this pressure limitation and to provide redundancy in the design of supply pipes and pumps to the upper zones of a standpipe system. When standpipe systems are subdivided to eliminate or avoid the use of pressure-reducing valves, such subdivisions should not constitute a standpipe system zone. [See Figure A.7.1(d) for vertically staged pumps for two-zone systems.]

A.7.9.2 It is the intent of 7.9.2 to require that each supply pipe have the ability to independently supply the entire flow and pressure required by Sections 7.8 and 7.10.

A.7.9.3 An auxiliary means can also be in the form of pumping through the fire department connection in series with the low- or mid-zone fire pump, as approved by the AHJ.

A.7.10.1.1 If a water supply system supplies more than one building or more than one fire area, the total supply can be calculated based on the single building or fire area requiring the greatest number of standpipes.

For a discussion of use by the fire department of fire department connections, see NFPA 13E.

A.7.10.1.1.2 The intent of this section is to provide a different flow requirement for large area low-rise buildings and other structures protected by horizontal standpipes.

Δ Table A.7.8 Hose Stream Friction Losses Summary

Calculation No.	Hose/Nozzle	Outlet Pressure		Flow	
		psi	bar	gpm	L/min
1	150 ft (45 m) of 2½ in. (65 mm) hose with an 1⅛ in. (28 mm) smooth bore nozzle	75	5.2	250	946
2	150 ft (45 m) of 2 in. (50 mm) hose with 2½ in. couplings with an 1⅛ in. (28 mm) smooth bore nozzle	94	6.5	240	908
3*	150 ft (45 m) of 2 in. (50 mm) hose with 1½ in. couplings with a 1 in. (25 mm) smooth bore nozzle	108	7.4	210	795
4*	150 ft (45 m) of 1¾ in. (44 mm) hose with a ⅞ in. (28 mm) smooth bore nozzle	118	8.1	165	625
5*	150 ft (45 m) of 1¾ in. (44 mm) hose with a 15/16 in. (28 mm) smooth bore nozzle	135	9.3	185	700
6*	150 ft (45 m) of 1½ in. (40 mm) hose with a 150 gpm @ 75 psi (568 L/min @ 5.2 bar) combination fog nozzle	161	11.1	150	568
7*	150 ft (45 m) of 1½ in. (40 mm)	186	12.8	150	568

Note: For a discussion of use by the fire department of fire department connections, see NFPA 13E.

*Require operation pressures above the minimum required hose connection residual pressure.

A.7.10.1.1.6 The situation in which a single hose connection is served by a lateral pipe is not considered a “horizontal standpipe,” because the definition of *horizontal standpipe* includes the idea that the pipe feeds two or more hose connections. Lateral runs of pipe, like those shown in Figure A.7.10.1.1.6, exist for convenience, but essentially they form additional standpipes that need to be taken into account in the hydraulics. For the system shown in Figure A.7.10.1.1.6 (hose connections in the stairwells with the standpipe as well as hose connections fed by lateral pipes on each floor), the hydraulic calculations should include 250 gpm (946 L/min) from hose connections A, B, C, D, and H if the building is not sprinklered or B, C, D, and H if the building is sprinklered in accordance with NFPA 13. This means that the standpipe serving the stairwell on the far right side will need to be capable of handling the flow of 750 gpm (2839 L/min) below node H because of the 250 gpm (946 L/min) flow at node C, the 250 gpm flow at node D, and the 250 gpm (946 L/min) flow at node H.

A.7.10.1.2 See Section 27.2 of NFPA 13.

When performing a hydraulic design, the hydraulic characteristics of each water supply need to be known. The procedure for determining the hydraulic characteristics of permanent water supplies, such as pumps, is fairly straightforward and is described in NFPA 20. The procedure for determining the hydraulic characteristics of fire apparatus supplying a standpipe system are similar. Lacking better information about local fire apparatus, a conservative design would accommodate a 1000 gpm (3785 L/min) fire department pumper performing at the level of design specifications set forth in NFPA 1901. NFPA 1901 specifies that fire department pumpers must be able to achieve three pressure/flow combinations. These are 100 percent of rated capacity at 150 psi (1034 kPa) net pump pressure, 70 percent of rated capacity at 200 psi (1379 kPa) net pump pressure, and 50 percent of rated capacity at 250 psi (1724 kPa) net pump pressure. Therefore, a 1000 gpm (3785 L/min) pumper can be expected to deliver no less than 1000 gpm (3785 L/min) at 150 psi (1034 kPa), 700 gpm (2650 L/min) at 200 psi (1379 kPa), and 500 gpm (1893 L/min) at 250 psi (1724 kPa). Residual supply pressure on the suction side of a pump from a municipal or other pressurized water supply can also be added. The 150 psi (1034 kPa) suggested pressure is also found in NFPA 13E. It also states that this is the pressure to be provided unless the sign at the fire department connection states otherwise. It is not the intent of this standard to limit the maximum pumper pressure at the fire

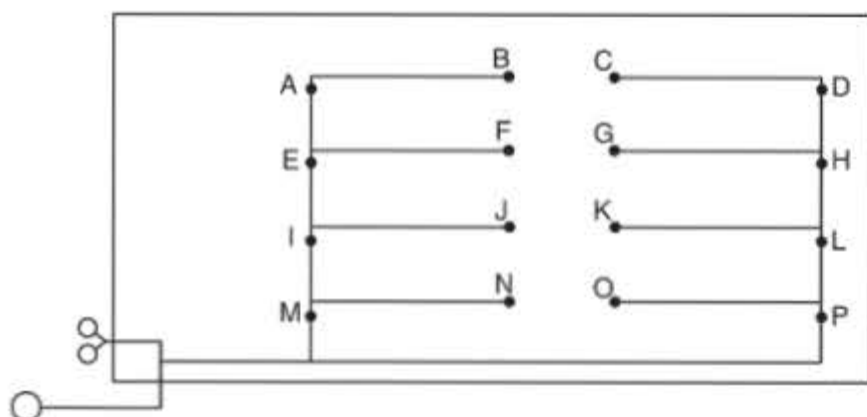

FIGURE A.7.10.1.1.6 Standpipe System with Single Hose Connections Served by a Lateral Pipe.

department connection inlet for manual or automatic standpipes to 150 psi (1034 kPa).

To perform a hydraulic design, one should determine the minimum required pressure and flow at the hydraulically most remote hose connection and calculate this demand back through system piping to each water supply, accumulating losses for friction and elevation changes and adding flows for additional standpipes and sprinklers at each point where such standpipes or sprinklers connect to the hydraulic design path. When considering fire apparatus as a water supply, flows are calculated from system piping through the fire department connection and back through connecting hoses to the pump. If the pressure available at each supply source exceeds a standpipe system’s pressure demand at the designated flow, the design is acceptable. Otherwise, the piping design or the water supply needs to be adjusted.

The intent of the standard is to require that each vertical standpipe serving two or more hose connections be capable of individually flowing 500 gpm (1893 L/min) and 250 gpm (946 L/min) at each of the two hydraulically most demanding connections at the required residual pressure. Given the requirement in 7.10.1.1.3 for the hydraulically most remote standpipe to supply this pressure and flow rate and given the minimum standpipe sizes in Section 7.6, the ability of standpipes that are not hydraulically most remote to satisfy this requirement is implicit and should not require additional hydraulic calculations.

A.7.10.1.2.1.1 For example, consider the standpipe system shown in Figure A.7.10.1.2.1.1 with two risers that terminate at the 15th floor and two risers that terminate at the 10th floor of this fully sprinklered high-rise building. In this case, two separate hydraulic calculations need to be performed. The first would verify that the system can deliver 100 psi (6.9 bar) to the top of the risers on the 15th floor with a total of 750 gpm (2840 L/min) flowing [250 gpm (946 L/min) each at points A, B, and C]. The second would need to prove that the system can deliver 100 psi (6.9 bar) to the 10th floor with a total of 1000 gpm (3785 L/min) flowing [250 gpm (946 L/min) each at points D, E, F, and G]. Note that since the building is sprinklered, there is no flow required from the fourth riser in this second calculation.

A.7.10.1.2.3 Flow is added at nodes in a standpipe system in 250 gpm (946 L/min) increments without requiring additional flow, which might occur from higher pressures at that node (balancing the system). The common supply piping should be hydraulically calculated based on the required flow rate [500, 750, 1000, or 1250 gpm (1893, 2840, 3785, or 4732 L/min)] for the standpipe system. The calculated pressure for the standpipe system does not have to be balanced at the point of connection to the common supply piping.

N A.7.10.1.2.3.1 Where separate buildings are created in accordance with the model building code, there can be horizontal exits between the buildings. The common supply piping will generally be installed on the bottom floor. The standpipes that should be calculated will be the most demanding group of standpipes located within each building. See Figure A.7.10.1.2.3.1.

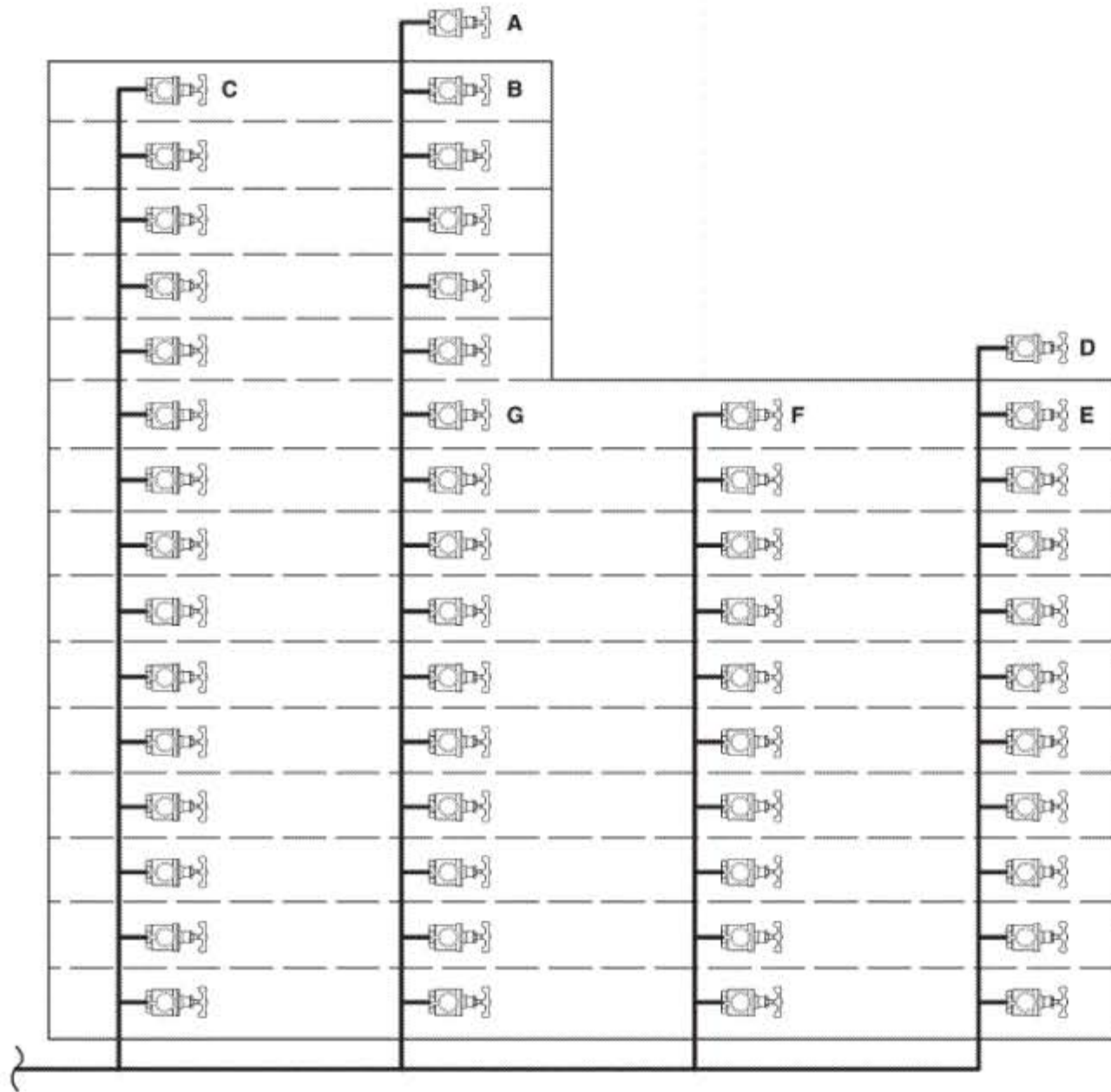
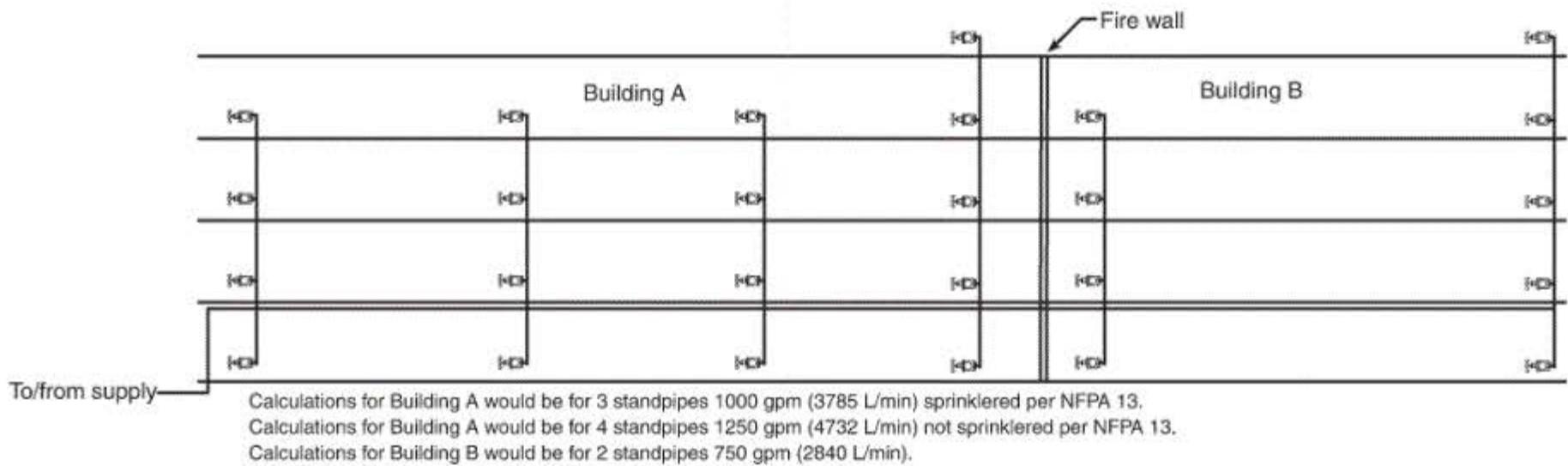

FIGURE A.7.10.1.2.1.1 Standpipe System with Risers Terminating at Different Floor Levels.



Δ FIGURE A.7.10.1.2.3.1 Common Supply Piping Standpipes Calculated.

A.7.11 During flow testing of pressure-reducing valves, care should be taken in making connections to drain risers. An air gap should be maintained in order to prevent cross-connection to nonpotable water sources.

N A.7.11.2.2.1 Where approved, it is acceptable to attach a hose to the lowest hose valve and run to a location that will not cause water damage.

A.7.12 See NFPA 13E.

The number of 2½ in. (65 mm) inlets to supply the required water volume and pressure at the fire department connection is dependent on several variables, such as the performance of the water supply at the source, the distance from the source to the location of the inlets, the diameter of the hose used, the size of the fire department pumper, and the required water volume and pressure at the base of the standpipe riser(s).

N A.7.12.2.2 For larger buildings, redundant fire department connections could be needed. Connections can be compromised by parked vehicles, damaged hose threads, debris in the intake piping, and other conditions such as falling debris from a fire above.

When a large campus-style facility is served by private fire service mains that feed the standpipe systems, and the campus covers a large area, additional fire department connections could be provided at strategic locations to enhance the fire department's ability to pump to the system.

A.8.1 Plans should indicate the type of fire department equipment that the system is designed to serve, including the hose size, hose length, and hose nozzle. Such equipment is the basis for the pressure selected in accordance with Section 7.8.

A.8.1.4 Manufacturer's material data sheets should be acceptable for meeting this requirement.

A.8.2.3 See Figure A.8.2.3(a), Figure A.8.2.3(b), Figure A.8.2.3(c), and Figure A.8.2.3(d) for copies of typical forms.

A.9.1 The selection of water supplies for each installation should be determined in cooperation with the AHJ.

A.10.1 Additional benefit is derived from waterflow tests by the indication of possible deficiencies, such as tuberculation of piping, closed valves, or other obstructions, which should be corrected to provide adequate waterflows.

A.10.2 Tests should be conducted in accordance with NFPA 291.

Δ A.11.1 Where standpipe connections are built into the walls or partitions, the hydrostatic tests should be made before they are covered or permanently sealed.

Example of Required Hydrostatic Test Pressure. The water supply for a standpipe system is the connection to a public water service main. A 100 psi (6.9 bar) rated pump is installed in the connection. With a maximum normal public water supply pressure of 70 psi (4.9 bar) at the low elevation point of the system or zone being tested and an 120 psi (8.3 bar) pump (churn) pressure, the hydrostatic test pressure is 70 psi + 120 psi + 50 psi, or 240 psi (4.8 bar + 8.3 bar + 3.4 bar, or 16.5 bar). (See NFPA 24 for permitted leakage in underground piping.)

A.11.4.1 The testing and flushing of the underground pipe should be in accordance with NFPA 24.

A.11.5.1 The hydraulically most remote hose connections in a building are generally at a roof manifold, if provided, or at the top of a stair leading to the roof. In a multizone system, the testing means is generally at a test header at grade or at a suction tank on higher floors.

Where a flow test at the hydraulically most remote hose connection is not practicable, the AHJ should be consulted for the appropriate location of the test.

A.11.5.2 It is not always necessary to use a pump to test a standpipe system. See Figure A.11.5.2(a), Figure A.11.5.2(b), and Figure A.11.5.2(c) for examples of possible test methods. Where using the method shown in Figure A.11.5.2(c), it is necessary to flow the system demand while observing the pressures at the FDC inlet and the hydraulically remote standpipe hose valve. While the standpipe test might indicate that a greater pressure is required at the FDC inlet than what was indicated in the hydraulic calculations, this is not necessarily a cause for failing the test. This greater pressure, if acceptable to the AHJ based on the ability of the fire apparatus to provide the additional pressure, should be incorporated into the standpipe sign required at the FDC by 6.4.5.2.2.

A.11.5.5.1 It is important to test pressure-regulating devices at the maximum and minimum anticipated flow rates. Minimum flow can be from a single sprinkler for combined systems or flow from a 1½ in. (40 mm) hose connection on standpipe systems that do not supply sprinklers. This can require a sustained flow to demonstrate the continued performance of the pressure-regulating device at the minimum flow rate.

The design documents should indicate the model and type of each pressure-regulating device as well as the inlet and outlet pressures based on the water supply data and hydraulic calculations. Many of these devices are custom built based on these pressures and must be installed in the proper location in the standpipe system.

A.11.9 It is the intent that the building owner retain the record drawings, equipment manual, and completed test report for the life of the standpipe system.

A.12.5 A substantial box, preferably of metal, should be located at the highest hose connection, in which a quantity of hose sufficient to reach all parts of the floor, a 1⅛ in. (29 mm) nozzle, spanner wrenches, and hose straps should be kept.

N A.13.2.1.3 The AHJ should take into account the unique nature of these systems and that materials listed for fire protection service might not be the most appropriate for outdoor and corrosive atmospheres. The use of piping such as CPVC, ductile-iron pipe, galvanized pipe, and HDPE have been used in these installations in many jurisdictions.

N A.13.2.1.4 Care should be given to selecting an HDPE pipe with a pressure rating that will be sufficient at the highest ambient temperature expected. HDPE pipe working pressure ratings are given at a specific temperature and de-rate as temperature increases.

N A.13.3.2 The potential for freezing conditions and available water supply in nearby building systems will determine which system type is the best choice for a particular installation.

HYDRAULIC CALCULATIONS for	
Project name:	_____
Location:	_____
Drawing no.:	_____ Date: _____
Design	
Remote area number:	_____
Remote area location:	_____
Occupancy classification:	_____
Density:	_____ gpm/ft ² (mm/min)
Area of application:	_____ ft ² (m ²)
Coverage per sprinkler:	_____ ft ² (m ²)
Type of sprinklers calculated:	_____
No. of sprinklers calculated:	_____
In-rack demand:	_____
Hose streams:	_____
Total water required (including hose streams):	_____ gpm (mm/min) @ _____ psi (bar)
Type of system:	_____
Volume of dry or preaction system:	_____ gal (l)
Water supply information	
Date:	_____
Location:	_____
Source:	_____
Name of contractor:	_____
Address:	_____
Phone number:	_____
Name of designer:	_____
Authority having jurisdiction:	_____
Notes: (Include peaking information or gridded systems here.) _____	

▲ FIGURE A.8.2.3(a) Summary Sheet. [13:27.4.5.1.2(a)]

FLOW TEST SUMMARY SHEET

$N^{1.85}$

Contract name and number: _____

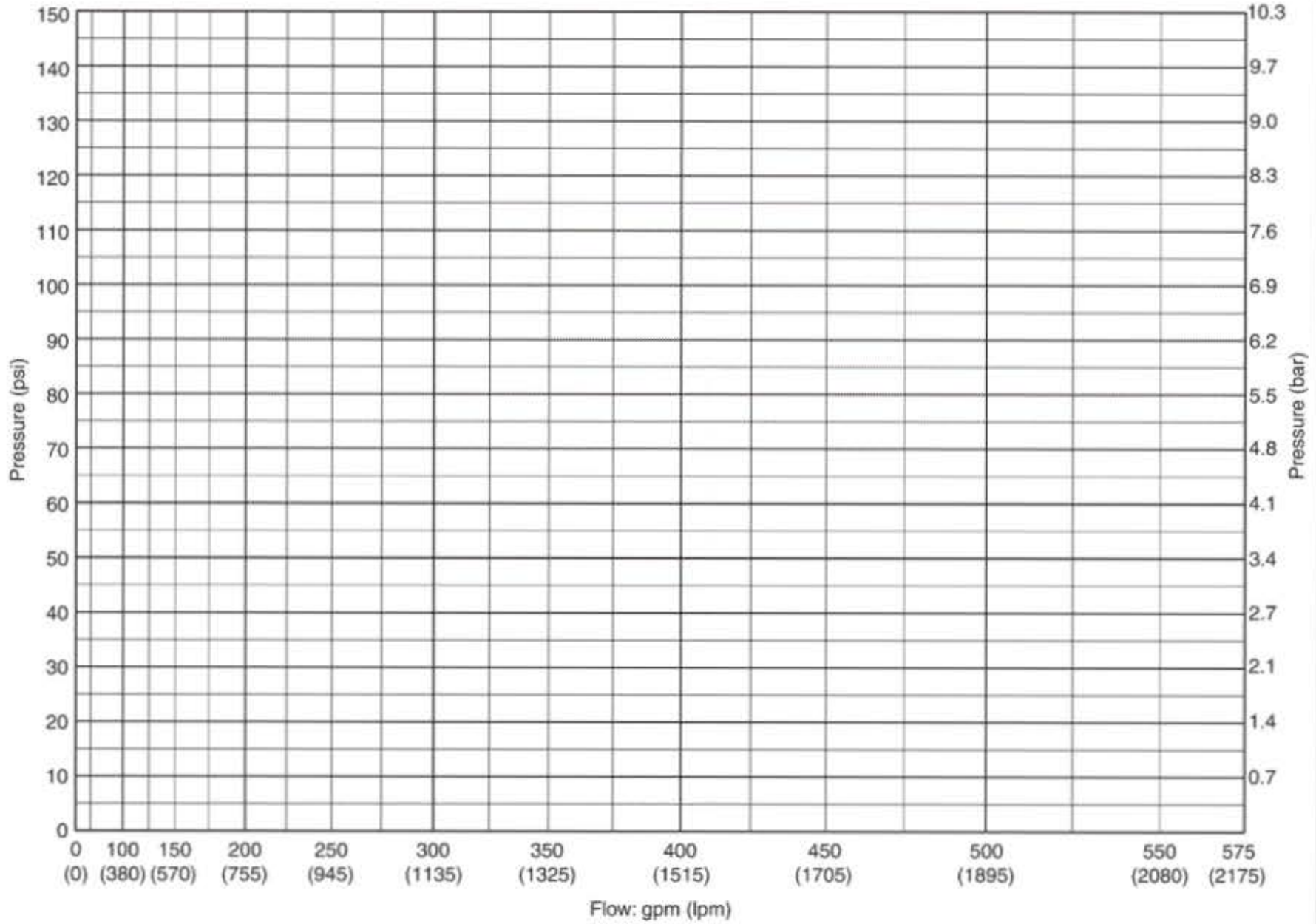

Notes: _____

▲ FIGURE A.8.2.3(b) Graph Sheet. [13:27.4.5.1.2(b)]

Job name: _____ Sheet number: _____

PIPE INFORMATION

Node 1	Elev 1 (ft) (m)	K- Factor	Flow added — this step (<i>q</i>)	Nominal ID	Fittings— quantity and length	L ft (m)	C Factor	total (<i>P_t</i>)	Notes
						F ft (m)		<i>P_f</i> per foot (m) (psi) (bar)	
Node 2			Total flow (<i>Q</i>)	Actual ID		T ft (m)		frict (<i>P_f</i>)	
data 1	data 1	data 1	data 1	data	data	data	data	data 1	data
					data	data	data	data	
data 2	data 2		data	data	data	data	data	data	
data 1	data 1	data 1	data 1	data	data	data	data	data 1	data
					data	data	data	data	
data 2	data 2		data	data	data	data	data	data	
data 1	data 1	data 1	data 1	data	data	data	data	data 1	data
					data	data	data	data	
data 2	data 2		data	data	data	data	data	data	
data 1	data 1	data 1	data 1	data	data	data	data	data 1	data
					data	data	data	data	
data 2	data 2		data	data	data	data	data	data	
data 1	data 1	data 1	data 1	data	data	data	data	data 1	data
					data	data	data	data	
data 2	data 2		data	data	data	data	data	data	
data 1	data 1	data 1	data 1	data	data	data	data	data 1	data
					data	data	data	data	
data 2	data 2		data	data	data	data	data	data	
data 1	data 1	data 1	data 1	data	data	data	data	data 1	data
					data	data	data	data	
data 2	data 2		data	data	data	data	data	data	

▲ FIGURE A.8.2.3(d) Detailed Worksheet. [13:27.4.5.1.2(d)]

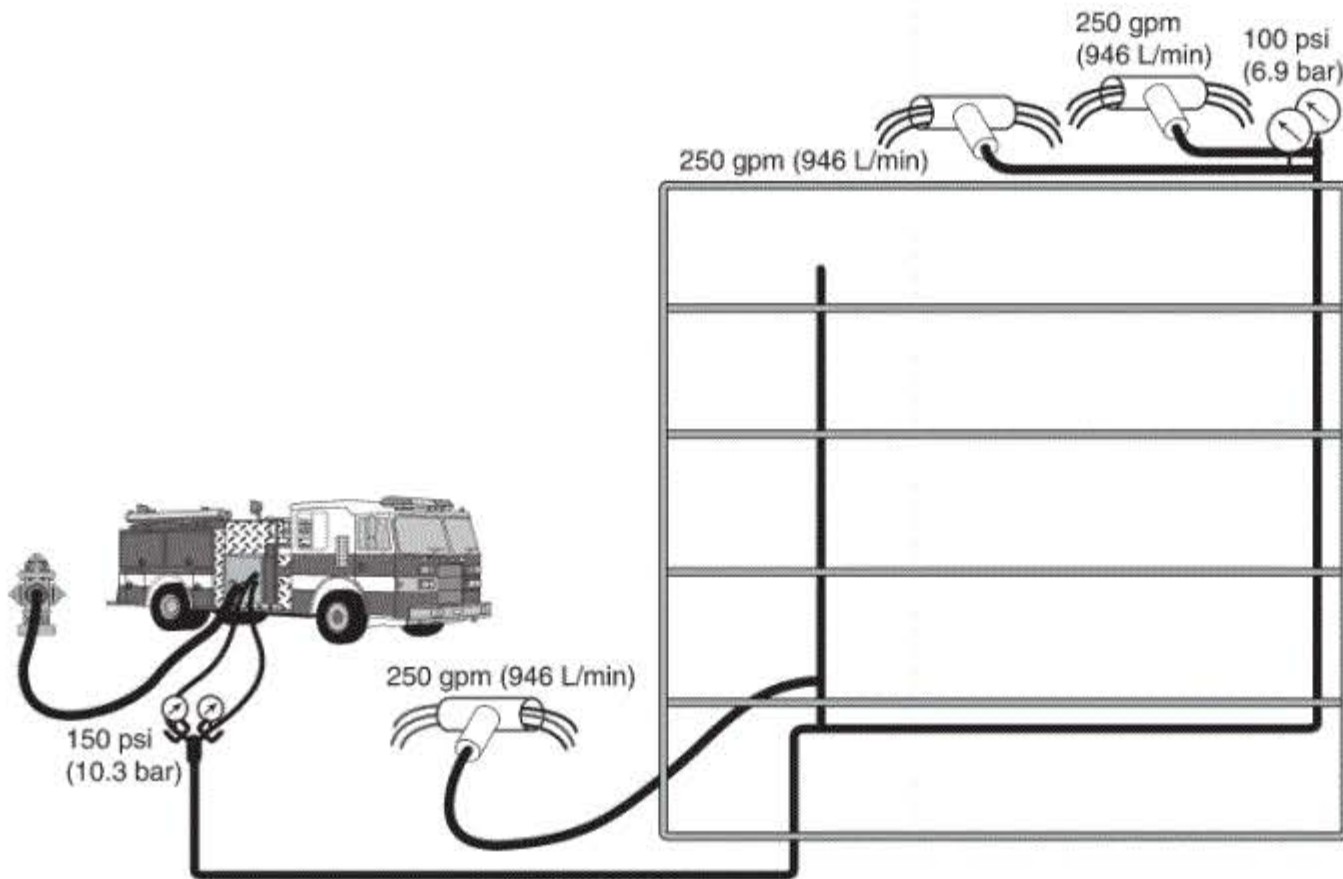

FIGURE A.11.5.2(a) Standpipe Flow Test Methods: Test With Pump Through FDC.

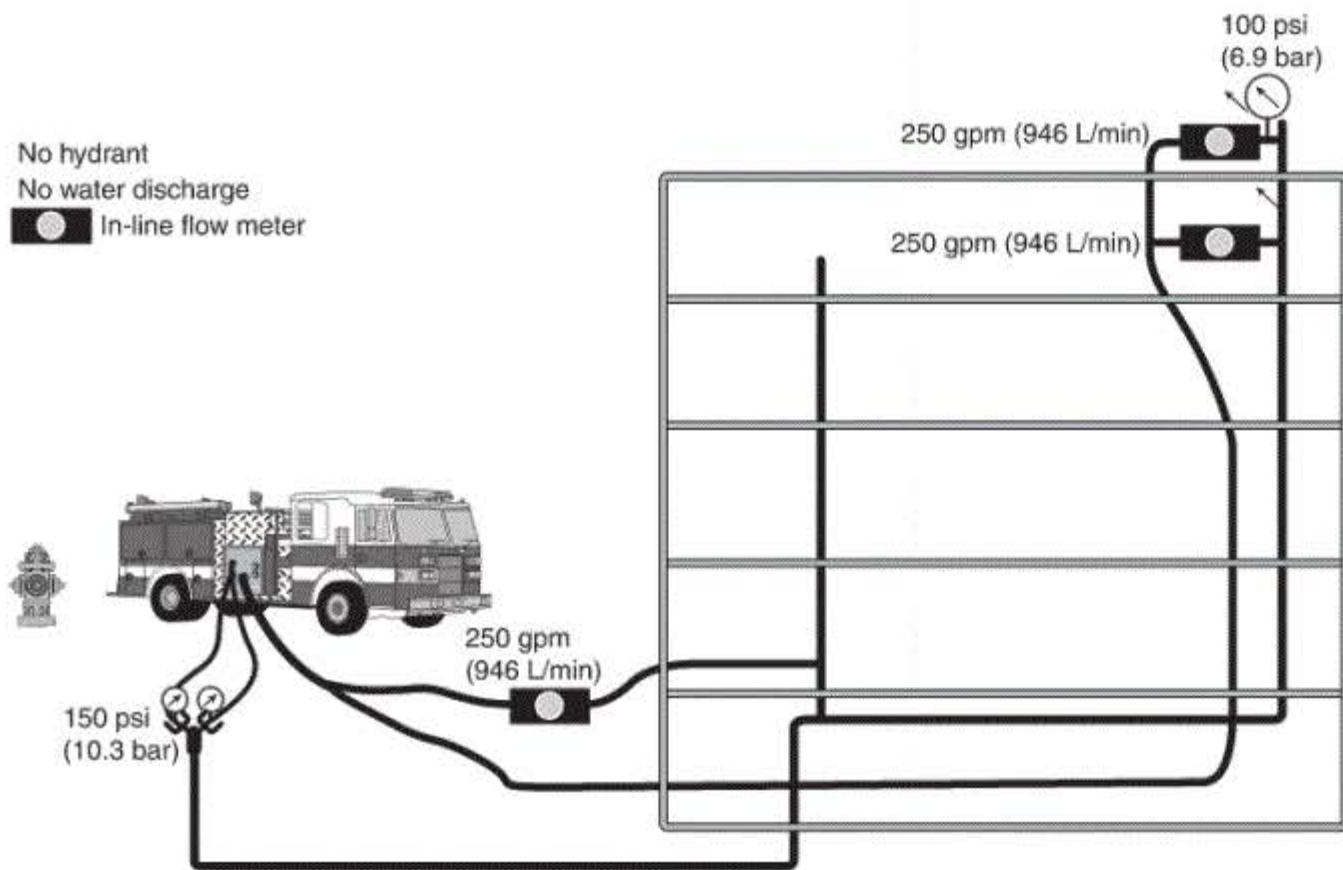

FIGURE A.11.5.2(b) Standpipe Flow Test Methods: Test by Recirculating Water.

	FDC	Valve
Test	75	25
Add	75	75
Total	150	100
Flow	750 gpm	

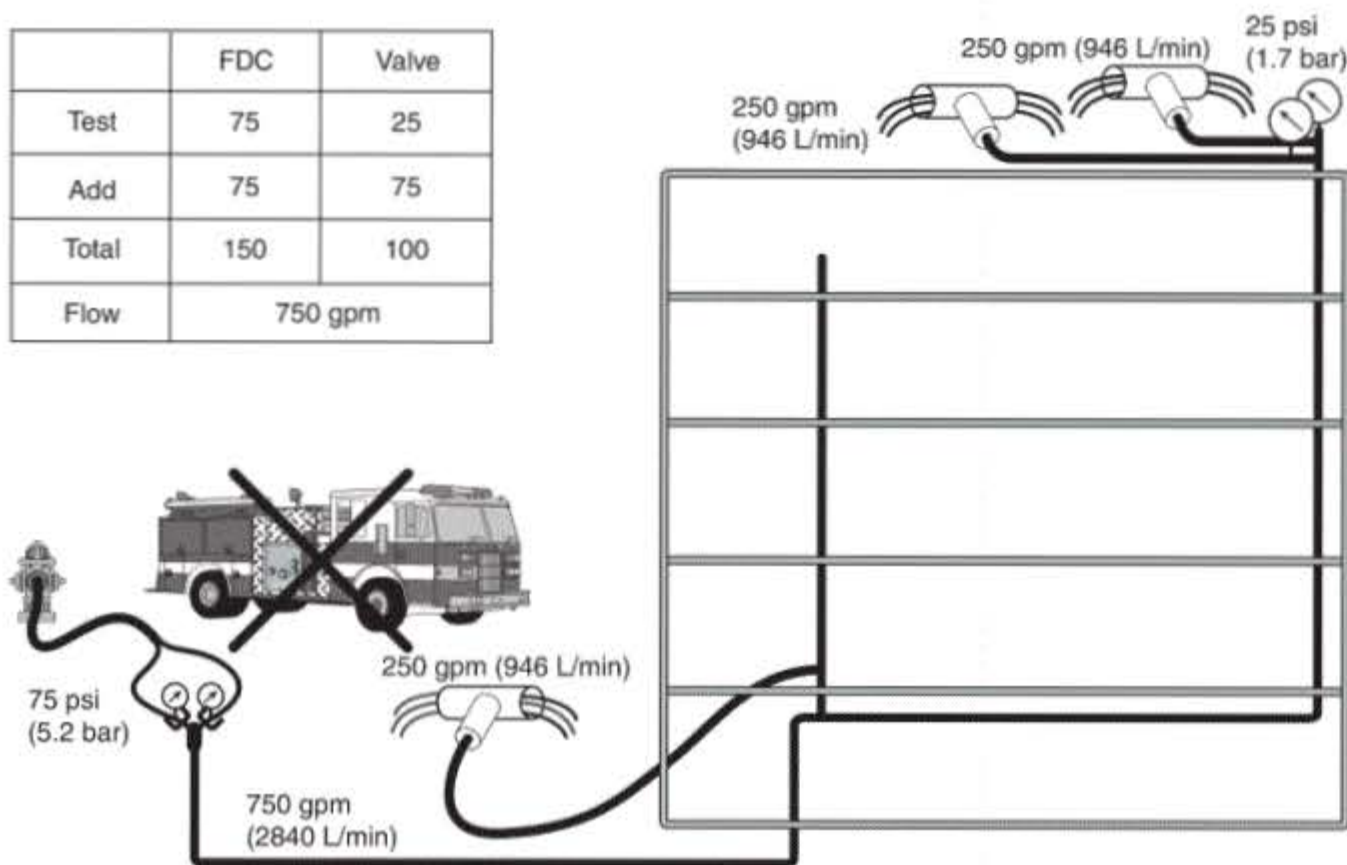

FIGURE A.11.5.2(c) Standpipe Flow Test Methods: Test Through FDC Without Pump.

Annex B Informational References

B.1 Referenced Publications. The documents or portions thereof listed in this annex are referenced within the informational sections of this standard and are not part of the requirements of this document unless also listed in Chapter 2 for other reasons.

B.1.1 NFPA Publications. National Fire Protection Association, 1 Batterymarch Park, Quincy, MA 02169-7471.

NFPA 13, *Standard for the Installation of Sprinkler Systems*, 2019 edition.

NFPA 13E, *Recommended Practice for Fire Department Operations in Properties Protected by Sprinkler and Standpipe Systems*, 2015 edition.

NFPA 13R, *Standard for the Installation of Sprinkler Systems in Low-Rise Residential Occupancies*, 2019 edition.

NFPA 20, *Standard for the Installation of Stationary Pumps for Fire Protection*, 2019 edition.

NFPA 24, *Standard for the Installation of Private Fire Service Mains and Their Appurtenances*, 2019 edition.

NFPA 25, *Standard for the Inspection, Testing, and Maintenance of Water-Based Fire Protection Systems*, 2017 edition.

NFPA 291, *Recommended Practice for Fire Flow Testing and Marking of Hydrants*, 2019 edition.

NFPA 600, *Standard on Facility Fire Brigades*, 2015 edition.

NFPA 1901, *Standard for Automotive Fire Apparatus*, 2016 edition.

NFPA 1964, *Standard for Spray Nozzles*, 2018 edition.

B.1.2 Other Publications.

B.1.2.1 ASME Publications. American Society of Mechanical Engineers, Two Park Avenue, New York, NY 10016-5990.

ASME B1.20.1, *Pipe Threads, General Purpose (Inch)*, 2013.

B.2 Informational References. The following documents or portions thereof are listed here as informational resources only. They are not a part of the requirements of this document.

B.2.1 AWWA Publications. American Water Works Association, 6666 West Quincy Avenue, Denver, CO 80235.

AWWA C116, *Protective Fusion Bonded Epoxy Coatings for the Interior and Exterior Surfaces of Ductile-Iron and Gray-Iron Fittings for Water Supply Services*, 2009.

B.2.2 SFPE Publications. Society of Fire Protection Engineers, 9711 Washingtonian Blvd, Suite 380, Gaithersburg, MD 20878.

SFPE, *Engineering Guide: Fire Safety for Very Tall Buildings*, 2013.

B.3 References for Extracts in Informational Sections.

NFPA 13, *Standard for the Installation of Sprinkler Systems*, 2019 edition.

Index

Copyright © 2018 National Fire Protection Association. All Rights Reserved.

The copyright in this index is separate and distinct from the copyright in the document that it indexes. The licensing provisions set forth for the document are not applicable to this index. This index may not be reproduced in whole or in part by any means without the express written permission of NFPA.

-A-

Administration, Chap. 1
 Equivalency, 1.4, A.1.4
 Purpose, 1.2
 Retroactivity, 1.3
 Scope, 1.1
 Units, 1.5

Approved

Definition, 3.2.1, A.3.2.1

Authority Having Jurisdiction (AHJ)

Definition, 3.2.2, A.3.2.2

Automated Inspection and Testing

Definition, 3.3.1

Auxiliary Drain Connection

Definition, 3.3.2, A.3.3.2

-B-

Branch Line

Definition, 3.3.3

Buildings Under Construction

, Chap. 12

Extension of System Piping, 12.6
 Fire Department Connections, 12.2
 General, 12.1
 Hose Connections, 12.5, A.12.5
 Other System Features, 12.3
 Protection of Hose Connections and Fire Department Connections, 12.9
 Support of Piping, 12.4
 Temporary Installations, 12.7
 Timing of Water Supply Installation, 12.8

-C-

Connection

Definition, 3.3.4
 Fire Department Connection
 Definition, 3.3.4.1
 Hose Connection
 Definition, 3.3.4.2

Construction Types

Definition, 3.3.5, A.3.3.5
 Type I and Type II Construction
 Definition, 3.3.5.1
 Type III Construction
 Definition, 3.3.5.2
 Type IV Construction
 Definition, 3.3.5.3
 Type V Construction
 Definition, 3.3.5.4

-D-

Definitions

, Chap. 3

Design

, Chap. 7

Drains and Test Riser, 7.11, A.7.11
 Drains, 7.11.2
 Fire Department Connections, 7.12, A.7.12
 Number of Fire Department Connections, 7.12.2
 Flow Rates, 7.10
 Class I and Class III Systems, 7.10.1
 Combined Systems, 7.10.1.3
 Flow Rate, 7.10.1.1, A.7.10.1.1
 Hydraulic Calculation Requirements, 7.10.1.2, A.7.10.1.2
 Class II Systems, 7.10.2
 Hydraulic Calculation Requirements, 7.10.2.2
 Minimum Flow Rate, 7.10.2.1
 Maximum Flow Rates for Individual Connections, 7.10.3
 Sprinkler System Hose Demand, 7.10.4
 General, 7.1, A.7.1
 Interconnection of Standpipes, 7.5, A.7.5
 Locations of Hose Connections, 7.3
 Class I Systems, 7.3.2, A.7.3.2
 Class II Systems, 7.3.3, A.7.3.3
 Class III Systems, 7.3.4
 General, 7.3.1, A.7.3.1
 Minimum and Maximum Pressure Limits, 7.8, A.7.8
 Minimum Design Pressure for Hydraulically Designed Systems, 7.8.1
 Minimum Sizes for Standpipes and Branch Lines, Class I and Class III Standpipes, 7.6
 Number of Standpipes, 7.4
 Pressure Limitation, 7.2, A.7.2
 Maximum Pressure at Hose Connections, 7.2.3, A.7.2.3
 Standpipe System Zones, 7.9, A.7.9
 System Design and Sizing of Pipe for Delivery of System Demand, 7.7

Distance Monitoring

Definition, 3.3.6

-E-

Exit

Definition, 3.3.7
 Exit Passageway
 Definition, 3.3.7.1
 Horizontal Exit
 Definition, 3.3.7.2, A.3.3.7.2

Explanatory Material

, Annex A

-F-

Fire Department

Definition, 3.3.8

-H-**High-Rise Building**

Definition, 3.3.9

Hose Station

Definition, 3.3.10

-I-**Informational References, Annex B****Installation Requirements, Chap. 6**

Fire Department Connections, 6.4, A.6.4

Location and Identification, 6.4.5

Gate Valves and Check Valves, 6.3

Connection to Water Supply, 6.3.1

Control Valves and Check Valves on Combined (Standpipe/
Sprinkler) Systems, 6.3.5, A.6.3.5Signs for Room Identification, Valves, and Hose
Connections, 6.3.8

Valve Supervision, 6.3.7

Valves on Connections to Water Supplies, 6.3.6

General, 6.3.6.1

Hydraulic Design Information Sign, 6.8, A.6.8

Installation of Signs, 6.6

Location and Protection of Piping, 6.1, A.6.1

Location of Dry Standpipes, 6.1.1

Protection of Aboveground Piping, 6.1.2

Signs for Water Supply Pumps, 6.7

Support of Piping, 6.5

Underground Piping, 6.2

-L-**Listed**

Definition, 3.2.3, A.3.2.3

-M-**Main**

Definition, 3.3.11

Feed Main

Definition, 3.3.11.1

Main Drain

Definition, 3.3.12

Maritime Standpipes and Hose Systems, Chap. 13

Application, 13.1

Components and Hardware, 13.2

Fire Department Connections, 13.2.7

Fittings, 13.2.2

Hose Connections, 13.2.6

Hose Stations, 13.2.5

Joining of Pipe and Fittings, 13.2.3

Restraint, 13.2.3.4

Pipe and Tube, 13.2.1

Pressure-Regulating Devices, 13.2.8

Signs, 13.2.9

Valves, 13.2.4

Design, 13.5

Drains, 13.5.7

Fire Department Connections, 13.5.8

Flow Rates, 13.5.5

Hydraulic Calculation Requirements, 13.5.6

Location of Hose Connections, 13.5.1

Class I Systems, 13.5.1.2

General, 13.5.1.1

Minimum Design Pressure for Hydraulically Designed
Systems, 13.5.4

Minimum Sizes for Standpipes and Branch Lines, 13.5.2

System Design and Sizing of Pipe for Delivery of System
Demand, 13.5.3

Installation, 13.4

Fire Department Connection, 13.4.2

Location and Identification, 13.4.2.3

Hydraulic Design Information Sign, 13.4.4

Location and Protection of Piping, 13.4.1

Flexibility, 13.4.1.6

Protection of System Piping, 13.4.1.5

Support of Piping, 13.4.3

Plans and Calculations, 13.6

System Acceptance, 13.9

System Inspection, Testing, and Maintenance, 13.10

System Requirements, 13.3

Water Supply, 13.7

Water Supply Testing, 13.8

-O-**Open Parking Garage**

Definition, 3.3.13

-P-**Plans and Calculations, Chap. 8**

Hydraulic Calculation Procedures, 8.3

Adjustments, 8.3.2

Formulas, 8.3.3

Friction Loss Formula, 8.3.3.1

General, 8.3.1

Differing Values, 8.3.1.6

Valves, 8.3.1.5

Hydraulic Calculations, 8.2

Detailed Worksheets, 8.2.5

Graph Sheet, 8.2.6

Summary Sheet, 8.2.4

Plans and Specifications, 8.1, A.8.1

Pressure

Definition, 3.3.14

Nozzle Pressure

Definition, 3.3.14.1

Residual Pressure

Definition, 3.3.14.2

Static Pressure

Definition, 3.3.14.3

Pressure Control Valve

Definition, 3.3.15

Pressure-Regulating Device

Definition, 3.3.16, A.3.3.16

Pressure-Reducing Valve

Definition, 3.3.16.1, A.3.3.16.1

- Pressure-Restricting Device
Definition, 3.3.16.2
- R-**
- Rated Capacity**
Definition, 3.3.17
- Record Drawing**
Definition, 3.3.18
- Referenced Publications**, Chap. 2
- S-**
- Shall**
Definition, 3.2.4
- Should**
Definition, 3.2.5
- Standard**
Definition, 3.2.6
- Standpipe**
Definition, 3.3.19
Horizontal Standpipe
Definition, 3.3.19.1
- Standpipe System**
Automatic Dry Standpipe System
Definition, 3.3.20.1
Automatic Wet Standpipe System
Definition, 3.3.20.2
Combined System
Definition, 3.3.20.3
Definition, 3.3.20, A.3.3.20
Manual Dry Standpipe System
Definition, 3.3.20.4
Manual Wet Standpipe System
Definition, 3.3.20.5
Semiautomatic Dry Standpipe System
Definition, 3.3.20.6
Wet Standpipe System
Definition, 3.3.20.7
- Standpipe System Zone**
Definition, 3.3.21
- System Acceptance**, Chap. 11
Alarm and Supervision Tests, 11.8
Automated Inspection and Testing Devices and Equipment, 11.7
Flow Tests, 11.5
Backflow Prevention Assemblies, 11.5.3
Main Drain Flow Test, 11.5.6
Pressure-Regulating Devices, 11.5.5
Testing of Automatic Dry and Semiautomatic Systems, 11.5.7
Flushing of Piping, 11.2
General, 11.1, A.11.1
Hose Threads, 11.3
Hydrostatic Tests, 11.4
Existing Systems, 11.4.7
Fire Department Connection, 11.4.6
Gauges, 11.4.9
General, 11.4.1, A.11.4.1
Protection from Freezing, 11.4.8
Water Additives, 11.4.11
- Manual Valve Test, 11.6
Record Drawings, Test Reports, and Manuals, 11.9, A.11.9
Signs, 11.10
- System Classes**
Class I System
Definition, 3.3.22.1
Class II System
Definition, 3.3.22.2
Class III System
Definition, 3.3.22.3
Definition, 3.3.22, A.3.3.22
- System Components and Hardware**, Chap. 4
Fire Department Connections, 4.8
Fittings, 4.3
General, 4.1, A.4.1
Automated Inspection, Testing, and Distance Monitoring
Devices, Meters, and Equipment, 4.1.4
Hose Connections, 4.7
Hose Stations, 4.6
Closets and Cabinets, 4.6.1
Hose, 4.6.2
Hose Racks, 4.6.3
Label, 4.6.5, A.4.6.5
Nozzles, 4.6.4
Joining of Pipe and Fittings, 4.4
Braze Joints, 4.4.4, A.4.4.4
End Treatment, 4.4.6
Groove Joining Methods, 4.4.3
Other Joining Methods, 4.4.5
Outlet Fittings, 4.4.5.2
Threaded Pipe and Fittings, 4.4.1
Welded Pipe and Fittings, 4.4.2
Fabrication, 4.4.2.2, A.4.4.2.2
Fittings, 4.4.2.3
General, 4.4.2.1
Qualifications, 4.4.2.5
Records, 4.4.2.6
Welding Requirements, 4.4.2.4
Pipe and Tube, 4.2
Bending of Pipe and Tube, 4.2.7
Pressure-Regulating Devices, 4.9
Signs, 4.10
Valves, 4.5
Automated Valves, 4.5.3
- System Demand**
Definition, 3.3.23
- System Requirements**, Chap. 5
Automatic and Semiautomatic Dry Systems, 5.2
Automatic Dry, 5.2.1, A.5.2.1
Air Pressure and Supply, 5.2.1.4
Air Supply, 5.2.1.4.2, A.5.2.1.4.2
Air Supply Connection, 5.2.1.4.3
Automatic Air Maintenance, 5.2.1.4.5
Maintenance of Air Pressure, 5.2.1.4.1
Nitrogen, 5.2.1.4.13
Relief Valve, 5.2.1.4.4
System Air Pressure, 5.2.1.4.9

Location and Protection of Dry Pipe Valve, 5.2.1.3, A.5.2.1.3	Class II and Class III Standpipe Systems, 5.4.2
General, 5.2.1.3.1, A.5.2.1.3.1	Waterflow and Supervisory Alarms, 5.6, A.5.6
High Water Level Protection, 5.2.1.3.3	System Working Pressure
Differential Dry Pipe Valve, 5.2.1.3.3.2	Definition, 3.3.24
High Water Level Device, 5.2.1.3.3.3	
Valve Rooms, 5.2.1.3.2	-T-
Pressure Gauges, 5.2.1.1	Travel Distance
Size of Systems Volume Limitations, 5.2.1.2	Definition, 3.3.25
Auxiliary Systems, 5.2.2	
Semiautomatic Dry, 5.2.3, A.5.2.3	-V-
Location and Protection of System Water Control Valves, 5.2.3.5	Valve
Valve Rooms, 5.2.3.5.2	Control Valve
Pressure Gauges, 5.2.3.4	Definition, 3.3.26.1, A.3.3.26.1
Classes of Standpipe Systems, 5.3	Definition, 3.3.26
Class I Systems, 5.3.1	Hose Valve
Class II Systems, 5.3.2	Definition, 3.3.26.2
Class III Systems, 5.3.3	
Gauges, 5.5, A.5.5	-W-
Pressure-Regulating Device, 5.5.2, A.5.5.2	Water Supply , Chap. 9
General, 5.1	Minimum Supply for Class I, Class II, and Class III Systems, 9.2
Required Type of System, 5.4, A.5.4	Required Water Supply, 9.1, A.9.1
Class I Standpipe Systems, 5.4.1	Water Supply Testing , Chap. 10
	Procedure, 10.2, A.10.2
	Water Supply Evaluation, 10.1, A.10.1

Sequence of Events for the Standards Development Process

Once the current edition is published, a Standard is opened for Public Input.

Step 1 – Input Stage

- Input accepted from the public or other committees for consideration to develop the First Draft
- Technical Committee holds First Draft Meeting to revise Standard (23 weeks); Technical Committee(s) with Correlating Committee (10 weeks)
- Technical Committee ballots on First Draft (12 weeks); Technical Committee(s) with Correlating Committee (11 weeks)
- Correlating Committee First Draft Meeting (9 weeks)
- Correlating Committee ballots on First Draft (5 weeks)
- First Draft Report posted on the document information page

Step 2 – Comment Stage

- Public Comments accepted on First Draft (10 weeks) following posting of First Draft Report
- If Standard does not receive Public Comments and the Technical Committee chooses not to hold a Second Draft meeting, the Standard becomes a Consent Standard and is sent directly to the Standards Council for issuance (see Step 4) or
- Technical Committee holds Second Draft Meeting (21 weeks); Technical Committee(s) with Correlating Committee (7 weeks)
- Technical Committee ballots on Second Draft (11 weeks); Technical Committee(s) with Correlating Committee (10 weeks)
- Correlating Committee Second Draft Meeting (9 weeks)
- Correlating Committee ballots on Second Draft (8 weeks)
- Second Draft Report posted on the document information page

Step 3 – NFPA Technical Meeting

- Notice of Intent to Make a Motion (NITMAM) accepted (5 weeks) following the posting of Second Draft Report
- NITMAMs are reviewed and valid motions are certified by the Motions Committee for presentation at the NFPA Technical Meeting
- NFPA membership meets each June at the NFPA Technical Meeting to act on Standards with “Certified Amending Motions” (certified NITMAMs)
- Committee(s) vote on any successful amendments to the Technical Committee Reports made by the NFPA membership at the NFPA Technical Meeting

Step 4 – Council Appeals and Issuance of Standard

- Notification of intent to file an appeal to the Standards Council on Technical Meeting action must be filed within 20 days of the NFPA Technical Meeting
- Standards Council decides, based on all evidence, whether to issue the standard or to take other action

Notes:

1. Time periods are approximate; refer to published schedules for actual dates.
2. Annual revision cycle documents with certified amending motions take approximately 101 weeks to complete.
3. Fall revision cycle documents receiving certified amending motions take approximately 141 weeks to complete.

Committee Membership Classifications^{1,2,3,4}

The following classifications apply to Committee members and represent their principal interest in the activity of the Committee.

1. **M** *Manufacturer*: A representative of a maker or marketer of a product, assembly, or system, or portion thereof, that is affected by the standard.
2. **U** *User*: A representative of an entity that is subject to the provisions of the standard or that voluntarily uses the standard.
3. **IM** *Installer/Maintainer*: A representative of an entity that is in the business of installing or maintaining a product, assembly, or system affected by the standard.
4. **L** *Labor*: A labor representative or employee concerned with safety in the workplace.
5. **RT** *Applied Research/Testing Laboratory*: A representative of an independent testing laboratory or independent applied research organization that promulgates and/or enforces standards.
6. **E** *Enforcing Authority*: A representative of an agency or an organization that promulgates and/or enforces standards.
7. **I** *Insurance*: A representative of an insurance company, broker, agent, bureau, or inspection agency.
8. **C** *Consumer*: A person who is or represents the ultimate purchaser of a product, system, or service affected by the standard, but who is not included in (2).
9. **SE** *Special Expert*: A person not representing (1) through (8) and who has special expertise in the scope of the standard or portion thereof.

NOTE 1: “Standard” connotes code, standard, recommended practice, or guide.

NOTE 2: A representative includes an employee.

NOTE 3: While these classifications will be used by the Standards Council to achieve a balance for Technical Committees, the Standards Council may determine that new classifications of member or unique interests need representation in order to foster the best possible Committee deliberations on any project. In this connection, the Standards Council may make such appointments as it deems appropriate in the public interest, such as the classification of “Utilities” in the National Electrical Code Committee.

NOTE 4: Representatives of subsidiaries of any group are generally considered to have the same classification as the parent organization.

Submitting Public Input / Public Comment Through the Online Submission System

Soon after the current edition is published, a Standard is open for Public Input.

Before accessing the Online Submission System, you must first sign in at www.nfpa.org. *Note: You will be asked to sign-in or create a free online account with NFPA before using this system:*

- a. Click on Sign In at the upper right side of the page.
- b. Under the Codes and Standards heading, click on the “List of NFPA Codes & Standards,” and then select your document from the list or use one of the search features.

OR

- a. Go directly to your specific document information page by typing the convenient shortcut link of www.nfpa.org/document# (Example: NFPA 921 would be www.nfpa.org/921). Sign in at the upper right side of the page.

To begin your Public Input, select the link “The next edition of this standard is now open for Public Input” located on the About tab, Current & Prior Editions tab, and the Next Edition tab. Alternatively, the Next Edition tab includes a link to Submit Public Input online.

At this point, the NFPA Standards Development Site will open showing details for the document you have selected. This “Document Home” page site includes an explanatory introduction, information on the current document phase and closing date, a left-hand navigation panel that includes useful links, a document Table of Contents, and icons at the top you can click for Help when using the site. The Help icons and navigation panel will be visible except when you are actually in the process of creating a Public Input.

Once the First Draft Report becomes available there is a Public Comment period during which anyone may submit a Public Comment on the First Draft. Any objections or further related changes to the content of the First Draft must be submitted at the Comment stage.

To submit a Public Comment you may access the online submission system utilizing the same steps as previously explained for the submission of Public Input.

For further information on submitting public input and public comments, go to: <http://www.nfpa.org/publicinput>.

Other Resources Available on the Document Information Pages

About tab: View general document and subject-related information.

Current & Prior Editions tab: Research current and previous edition information on a Standard.

Next Edition tab: Follow the committee’s progress in the processing of a Standard in its next revision cycle.

Technical Committee tab: View current committee member rosters or apply to a committee.

Technical Questions tab: For members and Public Sector Officials/AHJs to submit questions about codes and standards to NFPA staff. Our Technical Questions Service provides a convenient way to receive timely and consistent technical assistance when you need to know more about NFPA codes and standards relevant to your work. Responses are provided by NFPA staff on an informal basis.

Products & Training tab: List of NFPA’s publications and training available for purchase.

Information on the NFPA Standards Development Process

I. Applicable Regulations. The primary rules governing the processing of NFPA standards (codes, standards, recommended practices, and guides) are the NFPA *Regulations Governing the Development of NFPA Standards (Regs)*. Other applicable rules include NFPA *Bylaws*, NFPA *Technical Meeting Convention Rules*, NFPA *Guide for the Conduct of Participants in the NFPA Standards Development Process*, and the NFPA *Regulations Governing Petitions to the Board of Directors from Decisions of the Standards Council*. Most of these rules and regulations are contained in the *NFPA Standards Directory*. For copies of the *Directory*, contact Codes and Standards Administration at NFPA Headquarters; all these documents are also available on the NFPA website at "www.nfpa.org."

The following is general information on the NFPA process. All participants, however, should refer to the actual rules and regulations for a full understanding of this process and for the criteria that govern participation.

II. Technical Committee Report. The Technical Committee Report is defined as "the Report of the responsible Committee(s), in accordance with the Regulations, in preparation of a new or revised NFPA Standard." The Technical Committee Report is in two parts and consists of the First Draft Report and the Second Draft Report. (See *Regs* at Section 1.4.)

III. Step 1: First Draft Report. The First Draft Report is defined as "Part one of the Technical Committee Report, which documents the Input Stage." The First Draft Report consists of the First Draft, Public Input, Committee Input, Committee and Correlating Committee Statements, Correlating Notes, and Ballot Statements. (See *Regs* at 4.2.5.2 and Section 4.3.) Any objection to an action in the First Draft Report must be raised through the filing of an appropriate Comment for consideration in the Second Draft Report or the objection will be considered resolved. [See *Regs* at 4.3.1(b).]

IV. Step 2: Second Draft Report. The Second Draft Report is defined as "Part two of the Technical Committee Report, which documents the Comment Stage." The Second Draft Report consists of the Second Draft, Public Comments with corresponding Committee Actions and Committee Statements, Correlating Notes and their respective Committee Statements, Committee Comments, Correlating Revisions, and Ballot Statements. (See *Regs* at 4.2.5.2 and Section 4.4.) The First Draft Report and the Second Draft Report together constitute the Technical Committee Report. Any outstanding objection following the Second Draft Report must be raised through an appropriate Amending Motion at the NFPA Technical Meeting or the objection will be considered resolved. [See *Regs* at 4.4.1(b).]

V. Step 3a: Action at NFPA Technical Meeting. Following the publication of the Second Draft Report, there is a period during which those wishing to make proper Amending Motions on the Technical Committee Reports must signal their intention by submitting a Notice of Intent to Make a Motion (NITMAM). (See *Regs* at 4.5.2.) Standards that receive notice of proper Amending Motions (Certified Amending Motions) will be presented for action at the annual June NFPA Technical Meeting. At the meeting, the NFPA membership can consider and act on these Certified Amending Motions as well as Follow-up Amending Motions, that is, motions that become necessary as a result of a previous successful Amending Motion. (See 4.5.3.2 through 4.5.3.6 and Table 1, Columns 1-3 of *Regs* for a summary of the available Amending Motions and who may make them.) Any outstanding objection following action at an NFPA Technical Meeting (and any further Technical Committee consideration following successful Amending Motions, see *Regs* at 4.5.3.7 through 4.6.5.3) must be raised through an appeal to the Standards Council or it will be considered to be resolved.

VI. Step 3b: Documents Forwarded Directly to the Council. Where no NITMAM is received and certified in accordance with the Technical Meeting Convention Rules, the standard is forwarded directly to the Standards Council for action on issuance. Objections are deemed to be resolved for these documents. (See *Regs* at 4.5.2.5.)

VII. Step 4a: Council Appeals. Anyone can appeal to the Standards Council concerning procedural or substantive matters related to the development, content, or issuance of any document of the NFPA or on matters within the purview of the authority of the Council, as established by the Bylaws and as determined by the Board of Directors. Such appeals must be in written form and filed with the Secretary of the Standards Council (see *Regs* at Section 1.6). Time constraints for filing an appeal must be in accordance with 1.6.2 of the *Regs*. Objections are deemed to be resolved if not pursued at this level.

VIII. Step 4b: Document Issuance. The Standards Council is the issuer of all documents (see Article 8 of *Bylaws*). The Council acts on the issuance of a document presented for action at an NFPA Technical Meeting within 75 days from the date of the recommendation from the NFPA Technical Meeting, unless this period is extended by the Council (see *Regs* at 4.7.2). For documents forwarded directly to the Standards Council, the Council acts on the issuance of the document at its next scheduled meeting, or at such other meeting as the Council may determine (see *Regs* at 4.5.2.5 and 4.7.4).

IX. Petitions to the Board of Directors. The Standards Council has been delegated the responsibility for the administration of the codes and standards development process and the issuance of documents. However, where extraordinary circumstances requiring the intervention of the Board of Directors exist, the Board of Directors may take any action necessary to fulfill its obligations to preserve the integrity of the codes and standards development process and to protect the interests of the NFPA. The rules for petitioning the Board of Directors can be found in the *Regulations Governing Petitions to the Board of Directors from Decisions of the Standards Council* and in Section 1.7 of the *Regs*.

X. For More Information. The program for the NFPA Technical Meeting (as well as the NFPA website as information becomes available) should be consulted for the date on which each report scheduled for consideration at the meeting will be presented. To view the First Draft Report and Second Draft Report as well as information on NFPA rules and for up-to-date information on schedules and deadlines for processing NFPA documents, check the NFPA website (www.nfpa.org/docinfo) or contact NFPA Codes & Standards Administration at (617) 984-7246.



XchangeTM

The place to connect online with your fire, electrical, and life safety peers

Have a question about the code or standard you're reading now?

NFPA XchangeTM can help!

NFPA XchangeTM brings together over 30,000 professionals worldwide, asking and answering each other's questions, sharing ideas, and discussing the issues impacting your industry today.

NFPA XchangeTM is free to join and offers:

- A robust collection of previously asked and answered questions to search
- Access to thousands of peers for problem-solving and on-the-job advice
- NFPA blogs, white papers, and webinars in one convenient place

NFPA members also enjoy XchangeTM **Members Only**, the online space for technical questions* answered by NFPA staff, exclusive NFPA live events, and premier access to curated content.

Join NFPA XchangeTM TODAY!

www.nfpa.org/xchange

Xchange Today. Safer Tomorrow.

*For the full terms of use, please visit nfpa.org/standard_items/terms-of-use#xchange. NFPA[®] is a registered trademark of the National Fire Protection Association, Quincy, MA 02169.